



Project / Model

24.032

Mobile Lubrication/Tanker

Info

MWS 2.2.1.
Lubrication Reels

Date : 18.07.2024
Rev. : 00.00
Per. : Metin ALÇAR
Tel. : 0544 242 04 91
Mail : sales@aluratrailer.com

A 01

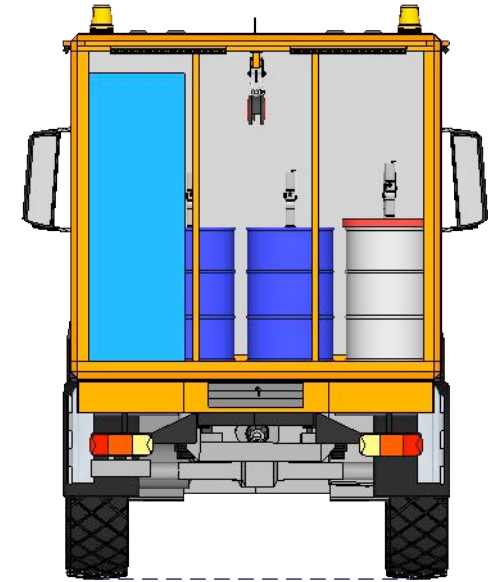
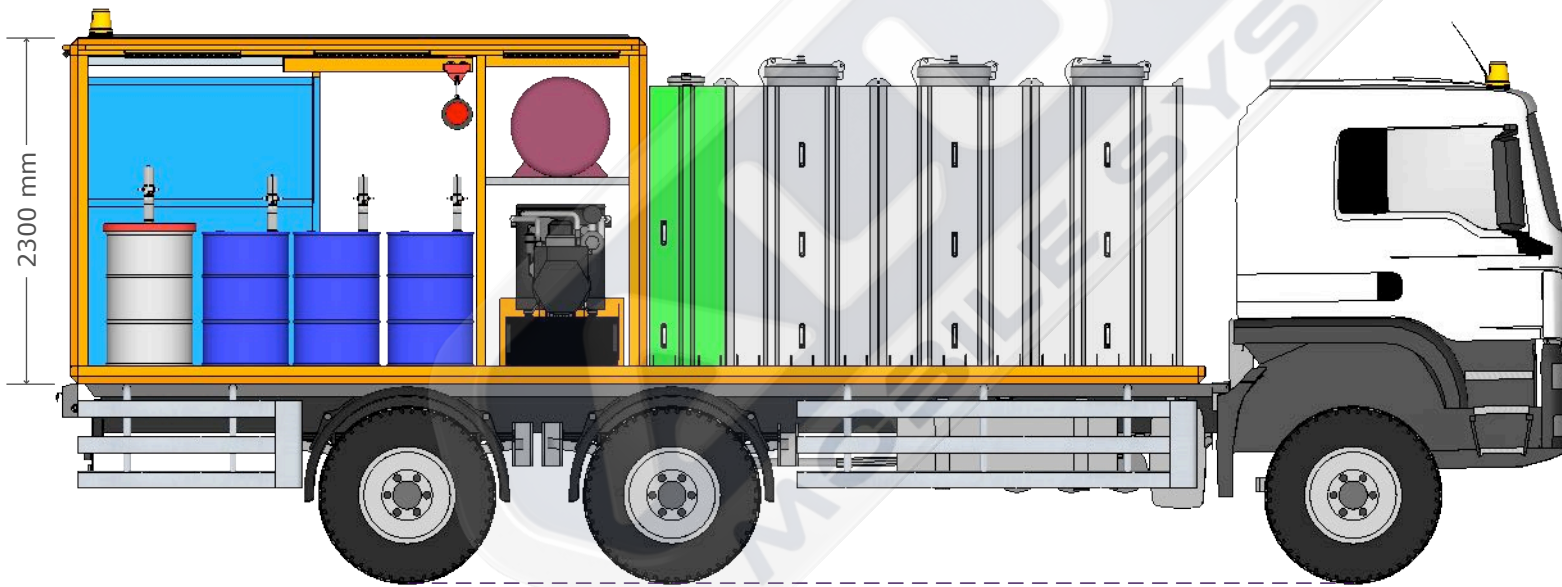
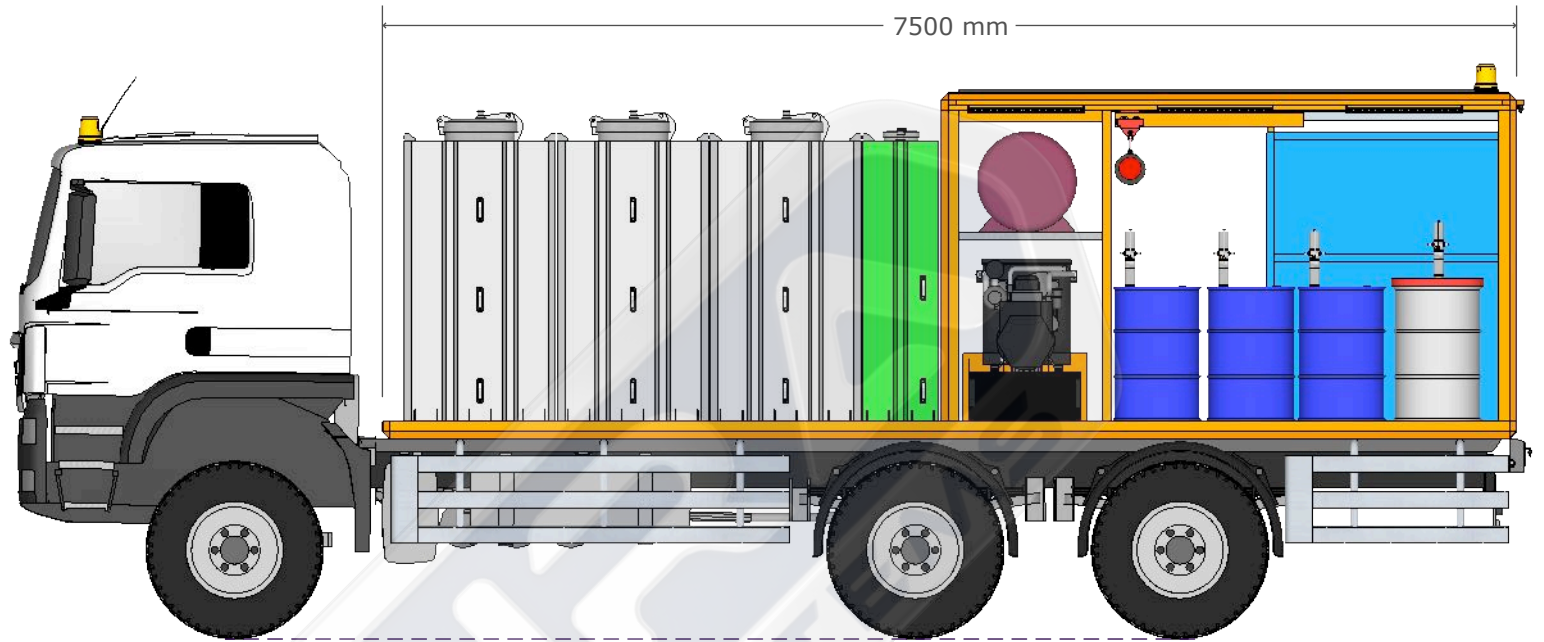
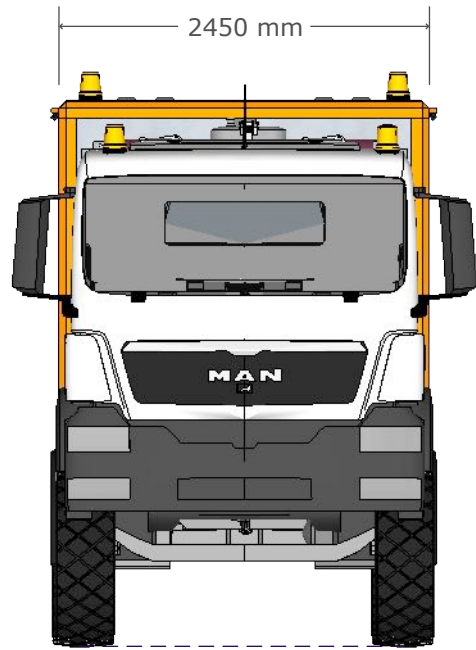

Project / Model

24.032

Mobile Lubrication/Tanker

Info

MWS 2.2.1.
Lubrication Reels

Date : 18.07.2024
Rev. : 00.00
Per. : Metin ALÇAR
Tel. : 0544 242 04 91
Mail : sales@aluratrailer.com

A 02

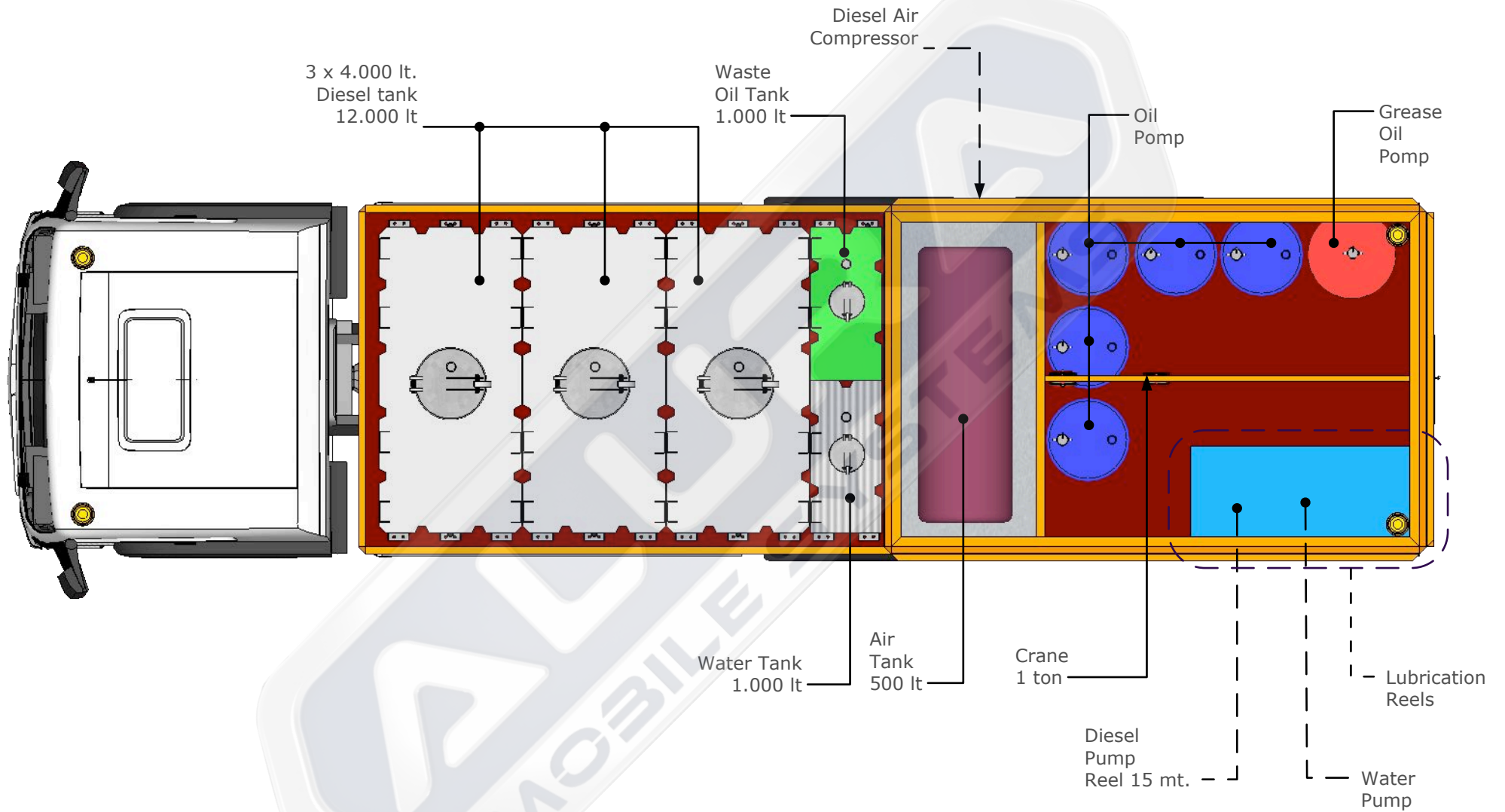

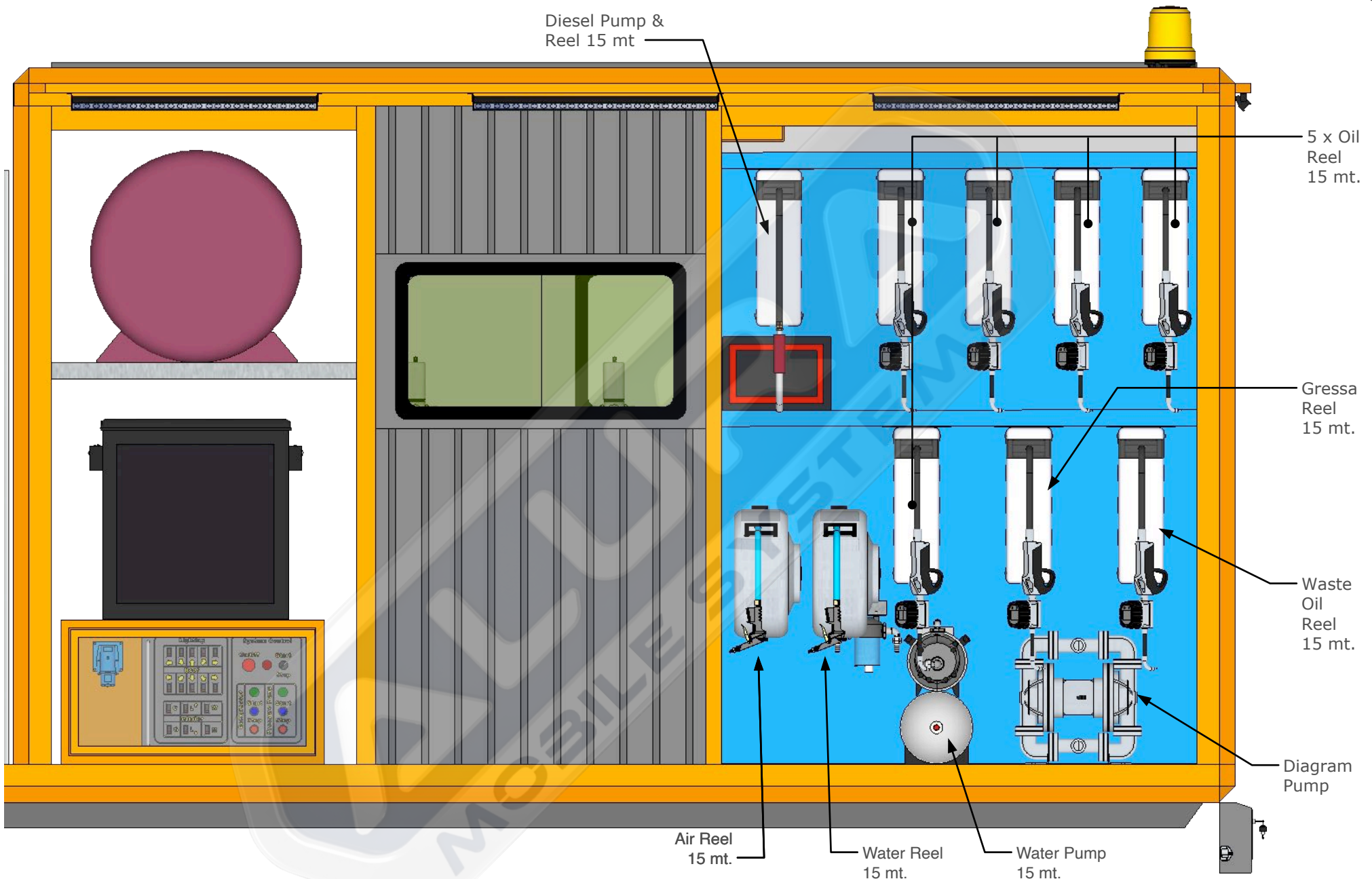







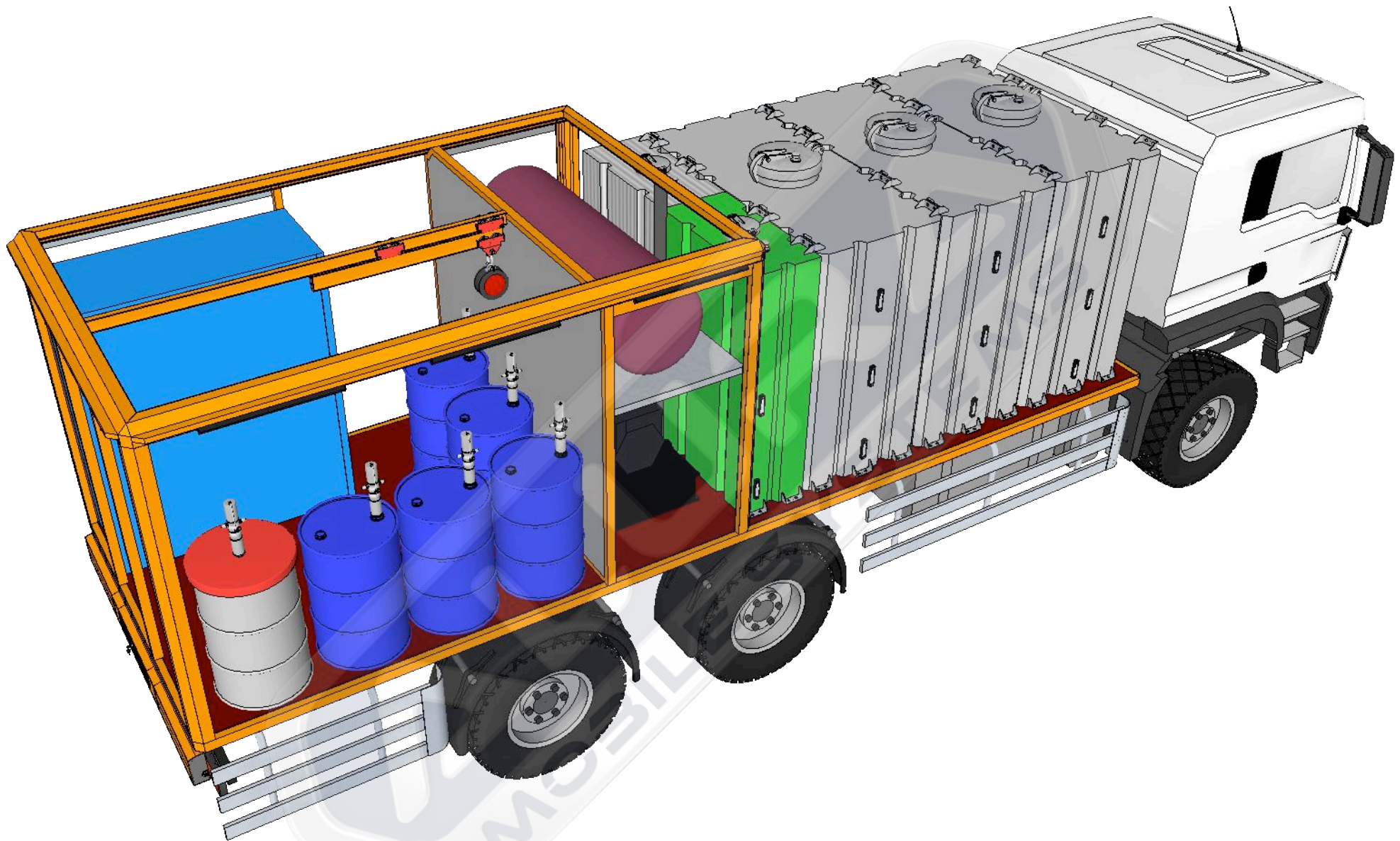

Project / Model

24.032

Mobile Lubrication/Tanker

Info

MWS 2.2.1.
Lubrication Reels

Date : 18.07.2024

Rev. : 00.00

Per. : Metin ALÇAR

Tel. : 0544 242 04 91

Mail : sales@aluratrailer.com





A





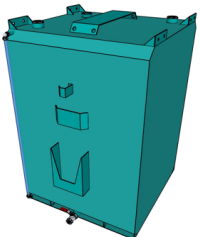

08





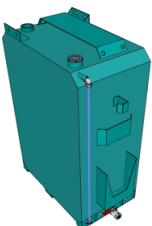

















No	Equipment	Explanation	Producer	Orjin	Piece
1	Bodywork		Alura	Turkey	1
		<p>MWS Insulated Body From twisted C type channel steel. Base traverses 80mm height 3mm 18 mm Elastomeric rubber insulation. Floor 18mm Plywood plywood. Sliding windows to usable areas. Generator and compressor areas are quickly accessible cover. Exhaust and ventilation device. Stainless hinges and locks. Outside transportation center control board. Electrical cables are hidden inside the insulated chassis.</p>			
		<p>Outside transportation center control board. Electrical cables are hidden inside the insulated chassis. Quick access cover to the lubricating and washing rollers. Monolithic crane connection channel to the body frame. Fixed glass rear door. Environmental and interior lighting 220v. Acrylic industrial chassis and surface paint. Quick-access rear bumper drawers. Metal items are fixed to the chassis.</p>			
2	Diesel Fuel tank 12.000 lt		Alura	Turkey	3
		<p>Material: ST 37 Carbon Steel Capacity: 4,000 lt. Sheet Thickness: 4 mm Fuel Output: 1 inch Level indicator Manhole Covers: 600 mm</p>			
		<p>Dimensions: 2000 x 1250 x 2000 mm Chassis mounted on vehicle</p>			
3	Diesel Pump		Piusu	Italy	1
		<p>Flow rate: 70 lt/min Power: 24 V / 420 Watt Suction distances: 4 mt. / 50 mt. Pressing distances: 30 mt. Sensitivity: +/- 1 Weight: 21 kg.</p>			
		<p>Counter: Piusi K33 Mechanical 3 Digit. With totalizer, resettable. Pistol 3/4" Automatic Calibration is possible</p>			
4	Diesel Hose Reel		Raasm	Italy	1
		<p>Pressure: 20 bar. Hose: 15 mt Compatible fluids: Diesel Seals: Polyurethane Material: Painted steel Inlet - Outlet: G 1"(f) - G 1"(f)</p>			
5	Water Tank		Alura	Turkey	1
		<p>Capacity : 1.000 Ltr Made of Stainless : 2,5 mm Level Indicator : Manuel Filling tap : 2" Pump stabilizer : 2 " Discharging valve : 1"</p>			
		<p>Material: Stainless Steel</p>			

No	Equipment	Explanation	Producer	Orjin	Piece
6	Water Pump		Seaflo	Germany	1
		Capacity: 18.9 L/Min. Volt: 24V Operation: Electric Volume: 8 Lt Maximum Pressure: 60 psi			
7	Water Hose Reel		Raasm	Italy	1
		Hose Diameter: 10x15 Mm Hose Length: 20 Mt Working Pressure: 15 Bar Inlet and Outlet Dim.: 3/8" F - 3/8" M Automatic Rewind Plastic outer casing	Steel rotating wall brake Size: 50x43.5x23.5 cm Weight: 8.3 Kg		
8	Waste Tank		Alura	Turkey	1
		Volume: 1.000 lt Metal prism tank Occupancy indicator Filler caps Pump stabilizer Discharge1" valve			
9	Waste Oil / Diagram Pump		Raasm	Italy	1
		Diaphragm Pumps Flow rate: 70 l / min Max pressure: 8 bar. Max cycles for minute: 400 cpm. Max working temperature: 100 ° C Noise level: 70 dB	Air working pressure: 2/6 Bar Membranes: EPDM		
10	Waste Oil / Hose Reel		Raasm	Italy	1
		Pressure: 20 bar Length: 15 mt Compatible fluids: Oils and Similar Material: Painted Steel Inlet-Outlet : G 1/2 ""f - G 1/2 ""m Pressure - Size: 1/2 "" - 160 bar			
11	Waste oil transfer		Özsay	Turkey	1
		Oil collection under the vehicle Swivel Wheel Metal case Capacity : 50 lt			

No	Equipment	Explanation	Producer	Orjin	Piece
12	Diesel Compressor / Model : M20 - Stationary		Kaeser	Germany	1
		Flow rate : 2.0 - 71 m3/min - cfm. Working pressure : 7 / 100 bar / psi. Diesel Engine water-cooled : Kubota Engine Model : D772 Rated engine power : 14 kW. Speed at full load : 3.600 rpm.		Fuel tank capacity : 30 lt. Operating weigh : 457 kg. Sound pressure level : 68 dBa. Air compressor will be mounted without its cabinet.	
13	Air Tank		Alura	Turkey	1
		Capacity : 500 lt. Working Pressure: 15 bar. Test Pressure: 15 Bar. Sheet Thickness: 4 mm. Compressor Connection : 1" Air Outlet : 1"			
14	Lubrication Grease		Raasm	Italy	1
		Grease disp. kit for drums external Ratio: 50:1 Flow rate: 1500 g/min For drums with internal: ø 370/420 Compatible fluids: Greases, medium / high viscosity		Air working pressure: 6/8 bar Average air consumption: 330 l / min Noise level: 81 dB Weight: 4.6kg Grease guns Grease coupler: special 4-jaw	
15	Grease Hose Reels		Raasm	Italy	1
		Pressure : 400 bar Compatible fluids : Grease ø and hose length : 3/8 - 15 mt. Swivel joint : Zinc plated steel Seals : Polyurethane Characteristic : Fixed		Material : Painted Steel Reel flow path : Zinc Pated Steel Internal drum width : 122 mm	
16	Oil Pumps		Raasm	Italy	5
		Pneumatic pumps for oil Flow rate: 18 l / min Air working pressure: 6/8 bar Average air consumption: 230 l / min Noise level: 81 dB Oil viscosity: 80 SAE			
17	Hose Reels		Raasm	Italy	5
		Pressure: 150 bar Length: 15 mt Compatible fluids: Oils and Similar Material: Painted Steel Inlet-Outlet : G 1/2 ""f - G 1/2 ""m Pressure - Size: 1/2 "" - 160 bar			

No	Equipment	Explanation	Producer	Orjin	Piece
18	Guns for dispensing		Raasm	Italy	5
		Flu: Technopolymer Digital meter: Yes Inlet swivel joint: G 1/2 f Filter: Yes Level locking button: Yes			
19	Air Hose Roller		Mavel	Italy	1
		Hose Diameter: 10x15 Mm Hose Length: 20 Mt Working Pressure: 15 Bar Inlet and Outlet Dim.: 3/8" F - 3/8" M Automatic Rewind Plastic outer casing	Steel rotating wall brake Size: 50x43.5x23.5 cm Weight: 8.3 Kg		
19	Aluminum Shutters		Alura	Turkey	3
		Manuel Working Locking Systems Size : 1000 x 2300 mm 2 pcs. 1500 x 2300 mm 1 pcs.			
20	Fire Extinguisher		Star	Japan	2
		ABC Grade Fire Extinguishing Powder 6 Kg Capacity MAP Rate 40% Body made of A1 7114 Quality Plastered Sheet 18 Bar Working Pressure	0.70 Micron Electro Static Paint It Has a Refillable Structure.		
21	Earthing Cable Reels		Raasm	Italy	1
		Environment temperature: -5 ÷ +40 °C Number of conductors : 1 Cable type : 1x16 - H07 V-K Cable length : 15 + 1 m Cable inlet : 1,2 m Current intensity : 100 A	Protection degree of electrical part : IP44 Gross weight : 8,8 kg		
22	Control panel of all equipment.		Alura	Turkey	1
		Generator / Mains power connection. Emergency Stop Lighting on/off Pressure indicator			

No	Equipment	Explanation	Producer	Orjin	Piece
23	Chain Hoist		Max Extra	Kore	1
		Capacity: 1 ton Lifting Height: 5 mt. Movement: 2 Type: Manual			
24	Outdoor Lighting		CSR	Turkey	6
		Operating Voltage / Current: DC 12/15V 1.4A Driving Type: Linear current and voltage controlled driver Light Source: 3W 12pcs power LED LENS Feature: 25° collimator LENS	White:5000-7000K Physical Properties : Polycarbonate plastic black aluminum profile		
25	Air Regulator		Osaka	Japan	2
		Air Inlet : 1/2" Filter : 20u Working Pressure: 05-9.9 atu Operating Temperature: 5-60°C Water Capacity: 80 ml Air Permeability: 2200 lt/min			
26	Air Line Connection		Osaka	Japan	1
		Polyurethane Pneumatic fittings			