

Project / Model

24.028

Mobile Workshop

Info

...

Date : 10.06.2024

Rev. : 24.06

Per. : Metin ALÇAR

Tel. : 0544 242 04 91

Mail : sales@aluratrailer.com

A 02

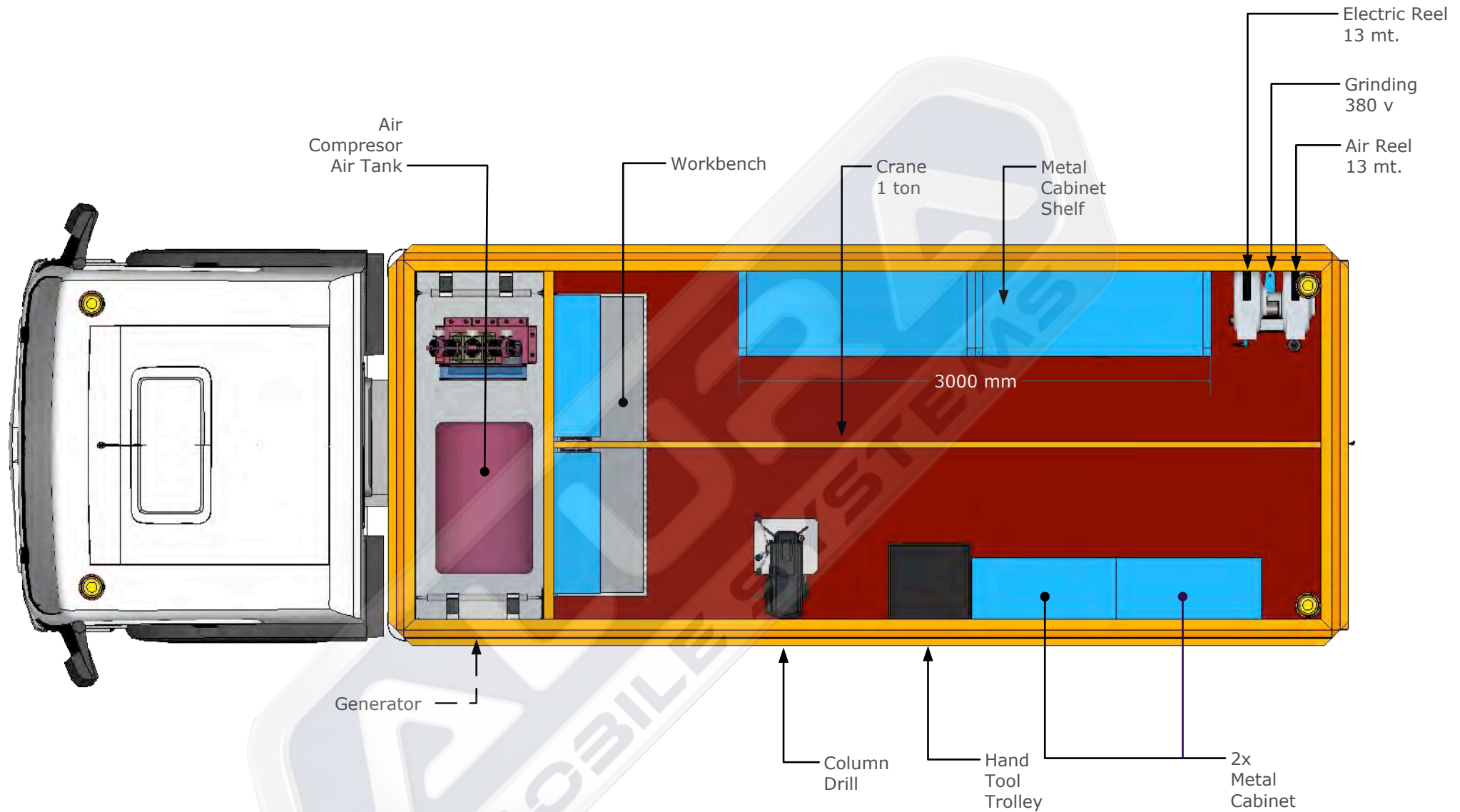



Project / Model

24.028

Mobile Workshop

Info

...

Date : 10.06.2024

Rev. : 24.06

Per. : Metin ALÇAR

Tel. : 0544 242 04 91

Mail : sales@aluratrailer.com

A

04



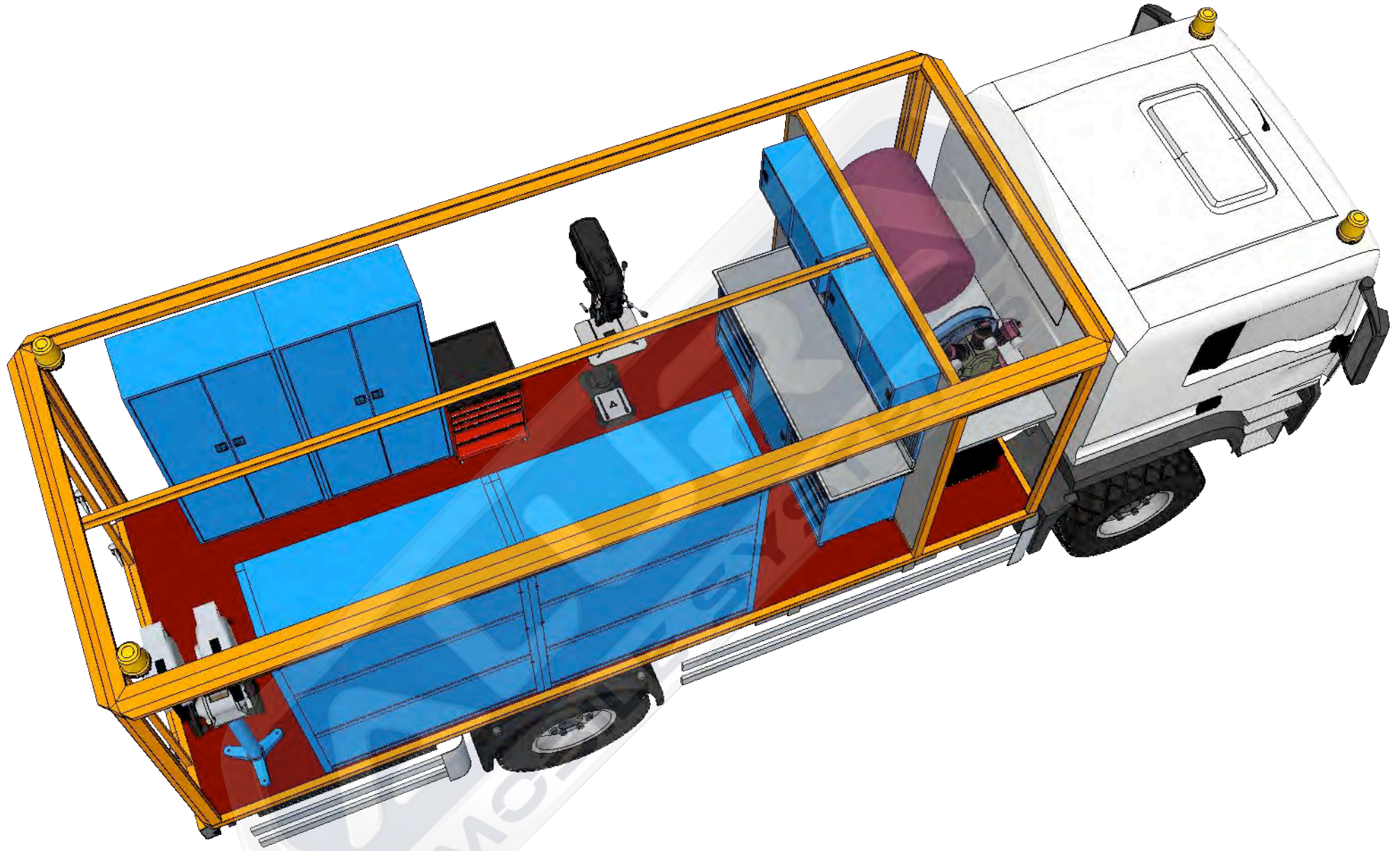

























No	Equipment	Explanation	Producer	Orjin	Piece
1	Bodywork				1
		<p>MWS Insulated Body From twisted C type channel steel. Base traverses 80mm height 3mm 18 mm Elastomeric rubber insulation. Floor 18mm Plywood plywood. Sliding windows to usable areas. Generator and compressor areas are quickly accessible cover. Exhaust and ventilation device. Stainless hinges and locks. Outside transportation center control board. Electrical cables are hidden inside the insulated chassis.</p>			<p>Outside transportation center control board. Electrical cables are hidden inside the insulated chassis. Quick access cover to the lubricating and washing rollers. Monolithic crane connection channel to the body frame. Fixed glass rear door. Environmental and interior lighting 220v. Acrylic industrial chassis and surface paint. Quick-access rear bumper drawers. Metal items are fixed to the chassis.</p>
2	Polyurea Surface Coating				1
		<p>Polyurethane Industrial Coating Resistant to chemicals. Hygienic, mold-proof, rust and corrosion-free. It maintains its elasticity between 40 C and +200 C heat. Fire resistant CLASS A certification. Solvent free, superior waterproofing. Elastic This product, which has an elasticity of 400%, will prevent cracks that may occur in the future by working in cooperation with the structure to which it is applied.</p>			<p>It prevents many damages that may occur due to impact on interior and exterior coatings. CE certified.</p>
3	Cable Roller		Mavel	Italy	1
		<p>20 Mt 5x2.5 mm Three Phase : 400 Volt Cable Thickness: 5x2.5 mm Cable Length: 20 Mt Cable Type : H07RN-F Power : 1000-3000 W</p>			<p>Auto Rewind Plastic outer cover steel swivel wall bracket Weight: 9 Kg Dimensions: 42x39x23 Cm</p>
4	Air Reel		Mavel	Italy	1
		<p>Hose Diameter: 10x15 Mm Hose Length: 20 Mt Working Pressure: 15 Bar Inlet and Outlet Dimension: 3/8" F - 3/8" M Automatic Rewind</p>			<p>Plastic outer casing steel swivel wall bracket It can be easily stopped by the end user thanks to the latched stop device. Size: 50x43.5x23.5 cm Weight: 8.3 Kg</p>



No	Equipment	Explanation	Producer	Orjin	Piece
5	Control panel		Alura	Turkey	1
		Control of all machines. Lighting control. Compressor Pressure gauge.			
6	Outdoor Lighting		CSR	Turkey	6
		Operating Voltage / Current: DC 12/15V 1.4A Driving Type: Linear current and voltage controlled driver Light Source: 3W 12pcs power LED LENS Feature: 25° collimator LENS	White:5000-7000K Physical Properties : Polycarbonate plastic black aluminum profile		
7	Lighting		EAT	Turkey	6
		Body : Polycarbonate RAL 9003 body , Metal lock clip Diffuser: Polycarbonate opal cover Light Source: Mid Power LED Power: 55 W Input Voltage: 220-240V - IP 65			
8	Aluminum Shutters		Alura	Turkey	6
		Manuel Working Locking Systems Size : 1000 x 2300 mm 2 pcs. 1500 x 2300 mm 1 pcs.			
9	Generator Diesel		Power	Turkey	1
		Standby/Prime Power: 28 kVa / 25 kVa Standard Voltage: 400/230 V / 3 Phase Engine Bran: Cummins Alternator: Stamford RPM: 1500 rpm. Water Cooling	Frequency: 50 Hz.		
10	Work Bench		Alura	Turkey	1
		Work Bench Width: 1.800 mm Depth: 700 mm Height: 2.000 mm Number of Drawers: 10 Drawer Carrying Capacity: 60 kg.	Shelf Carrying Cap .: 80 kg. Socket 2 Pieces 25 mm MDF + Pvc on worktops Electrostatic powder paint Suspension boards modular		





No	Equipment	Explanation	Producer	Orjin	Piece
11	Bench Top Column Drill		Forenam	Taiwan	1
		Drilling Capacity: 16 mm Pinole Diameter: 40 mm Pinole Movement: 80 mm Spindle Column Distance: 163 mm Spindle Tip: MT2 Spindle Speeds: 180-2.770 rpm			
		Spindle Speed: 16 pcs. Table Size: 170x175 mm Spindle Table Distance: 450 mm Spindle Base Distance: 630 mm Engine / Voltage : 550W / 380V Weight: 45 Kg.			
12	Grinding Machine		Workman	Taiwan	1
		Grinding Diameter: 200 mm Horsepower: 0.75 HP Voltage: 230 Volts. Speed: 3,000 rpm.			
13	Chain Hoist		Max Extra	Kore	2
		Capacity: 1 ton Lifting Height: 5 mt. Movement: 2 Type: Manual			
14	Pistone Compressor AC 75		Atlas Copco	Belgium	1
		Chassis Piston Air Compressor Engine Power: 7.5 hp Air Intake: 836 lt/min Revolution : 663 rpm Pressure : 15 bar Working Power : 380 V			
15	Air Tank		Alura	Turkey	1
		Capacity : 300 lt. Working Pressure: 16 bar. Test Pressure: 16 Bar. Sheet Thickness: 4 mm. Compressor Connection : 1" Air Outlet : 1/2"			
16	Metal Cabinet		Alura	Turkey	1
		WxDxH: 1.000 x 450 x 2.000 mm Body and carriers 0.80 - 1.2 mm It is long-lasting and durable. The covers are double wing reinforced. Number of Shelves: 7 Pieces Shelf Carrying Cap .: 80 kg.	Variable drawer groups		

No	Equipment	Explanation	Producer	Orjin	Piece
17	Metal Cabinet		Alura	Turkey	2
		Metal Cabinet Width: 1.000 mm Depth: 450 mm Height: 2000 mm Number of Shelves: 7 Pieces Shelf Carrying Cap .: 80 kg.	Variable drawer groups Body and carriers 0.80 - 1.2 mm sheet metal It is long-lasting and durable. The covers are double wing reinforced.		
18	Portable A Frame		Mertaş	Turkey	1
		Lifting Capacity: 1,000 kg. Tower width: 3.800 mm. Lifting Max/Min.: 3.100/1.900 mm. Wheel Clearance: 1.510 mm. Weight: 135 kg. It can be disassembled and moved.	It can be easily transported as it can be assembled and disassembled easily and quickly. It allows the work to be done easily and quickly by being installed on the construction site.		
19	Folding Wheelbarrow				1
		Telescopic foldable Folding Rubber Wheel Carrying Capacity: 70 KG Place Diameter: 50 cm Width: 40cm Height (Long Version): 100 cm	Height (Closed): 65 cm		
20	209 Piece Tool Set		İzeltaş	Turkey	1
		Metal material drawer: 5 pcs With EVA sponge inside the drawer lockable Top is plastic portable on wheels Pulls full of hand tools 209 Piece			
21	Copper Hammer.		Beta	Türkiye	1
		Weight: 1,000 gr. Length: 280 mm. Height: 100 mm Thickness: 37 mm. It doesn't make a spark.			
22	Tyvek 600 Plus Chemical Protective Coverall		Dupont	France	10
		Type 4 – Protection against liquid aerosols (EN 14605) Type 4B – Biological protection (EN 14126) Type 5 – Protection against airborne solid particulate chemicals	Type 6 – Limited protection against liquid smoke (EN 13034)		

No	Equipment	Explanation	Producer	Orjin	Piece
23	Industrial Raincoat		Ismont	Turkey	5
		Zippered front, wind protector on top Reflective tapes on front, back body and arms 2 large pockets for safe transport Concealable hood Concealed elastic arm cuffs	Fabric: 100% Polyester, PVC Coating - 145 gr/m ²		
24	Face Protection Mask		Ennes	France	5
		To prevent forehead discomfort. The collapsible visor can be fixed with the screws on the sides There is a protective tape on the transparent visor, sold separately as a spare.			
25	Industrial Boots		Ismont	Turkey	5
		Antistatic, Waterproof, Shock Absorbing Heel, Non-wearing Sole Oil Resistant Base Non-Slip Base Hot Insulation Cold Insulation	Electrostatic Discharge Length 37cm		
26	Liquid Proof Gloves		Mapa	Turkey	10
		Material: Natural latex Color: Blue Inner Lining: Fabric reinforcement Outer Coating: Rough Length: 29-33 cm Thickness: 1.15 mm			
27	Oil Absorbent Socks		Ergon	Turkey	4
		Dimension: 12cm x 300 cm. Absorption capacity: 230 Lt Weight: 11,5 kg Ideal for separating oil, petroleum and waste materials from water. Fully synthetic and high absorbency	Thanks to its strong network structure, it traps foreign substances within itself.		
28	Oil Separators		Ergon	Turkey	1
		It is effective in decomposing oils accumulated on the sea surface, shores and shores or on decks. It can dissolve mineral oils, crude oils and fuel-oil residues.			

No	Equipment	Explanation	Producer	Orjin	Piece
29	Hand Scoops		Ergon	Turkey	1
		Non-sparking hand scoops are ideal in a spill kit for distributing ground and ground absorbent upon a spill. The scoop will not rust, rot or spark. It is resistant to oils and chemicals.			
30	Non-Sparking Shovel		Ergon	Turkey	2
		It is made of fiberglass, which is a non-sparking safety device. It also does not scratch or scrape the tank's protective coating during sedimentation.	Heavy-duty, lightweight and the most suitable tool for sludging oil tanks.		
31	Hand Sanitizer		Valvolin	Turkey	1
		4.5Kg Biodegradable gel Antiseptic rapid hand cleaner. Removes oil, grease, paint, tar, oil-based inks, creosote, resins, waxes and rubber compounds.	Warning – Do not use the cleanser too close to eyes or other sensitive areas.		
32	Brooms		Ergon	Turkey	2
		Resistant to oil liquids. Steel handle.			
33	Oil Absorber		Ultrasorb	Turkey	1
		Powder 25Kg			
34	Protection Glasses		3M	Turkey	2
		Glasses Type: Leakproof Eye Protection: Range Premium Lens Coating: Anti-Scratch and Anti-condensation Lens Color: Tint 5.0 IR	Recommended Application: Industrial working environments Standard: EN 169:2002 Product Type: Safety Glasses		

No	Equipment	Explanation	Producer	Orjin	Piece
35	Oil Spill Box		Ergon	Turkey	1
		Oil Spill Waste Container Material: Plastic It does not leak. Locked cover. Dimensions: 70x70x80 cm			
36	Garbage Bag		Ergon	Turkey	2
		Volume: 125 liters Type: Industrial.			
37	Portable Hand Sprayer		Ergon	Turkey	1
		5 Liters Shoulder strap Environmental solution cleaning			
38	Manual Hand Pump		Ergon	Turkey	1
		Plastic With delivery and suction hose Oil and fuel resistant Used as a bilge pump or to pump other liquids It is made of non-sparking material.			
39	Electric Fan (ex-proof)				1
		Motor: 245W 240V 50/60Hz Fan diameter: 20 cm x 9 blades Amperage: 1.2 in Weight: 10kg Dimensions (HxWxL): 36 x 31 x 36 cm Blowing and suction feature	Robust, durable anti-static body Double layer rigid structure Lightest device in its class / 10 kg proof power connection plug IEC 309 Anti-static hose in canister		
40	Multi Gas Measurement Device		BW Tech.	USA	1
		Dimensions: 11.3 x 6.0 x 3.1 cm Weight: 190g Operating Temperature: -20 ... +50°C Operating Humidity: 0% - 95% RH (Non-condensing) Cold Weather Battery Life: 12 hours	Alarms: Light, vibration, sound (95 dB), lower-upper limit, STEL, TWA Test: Audible and visual sensor, battery and continuity test Battery Life: 18 hours @20°C – charging in less than 6 hours		

No	Equipment	Explanation	Producer	Orjin	Piece
39	Air Tube Breathing Set		Draeger	Italy	1
			6 liters 300 Bar Steel air tube Early warning system siren when 50 bar drops positive pressure full face mask, Carrying plate (backrest) Harness fire resistant	Pressure reducer Manometer Rubber Coated Shockproof lung automaton, Antistatic air hose, Complete with air cylinder valve and manometer.	
40	Confined Space Working System		Rock	Italy	1
	3-leg system provides easy and stable installation. It can be adjusted in 8 stages according to the work area. Feet made of high strength aluminum. Top port stainless steel.	There are 2 anchor points. It has a carrying capacity of 300 kg.			
41	Safety belt		Rock	Italy	2
	5-point seat belt 2 front, 1 back, 2 side Positioning waist belt with integrated pad.				