

Project / Model

23.026

40 ft Container Service

Info

40 ft Iso Container

Date : 12.12.2023

Rev. : 00.00

Per. : Metin ALÇAR

Tel. : 0544 242 04 91

Mail : sales@aluratrailer.com

A 01

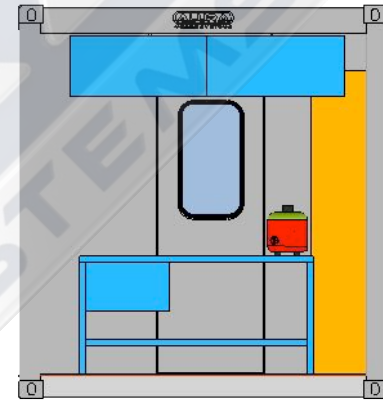
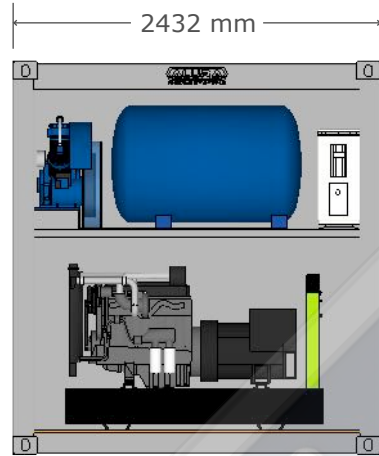
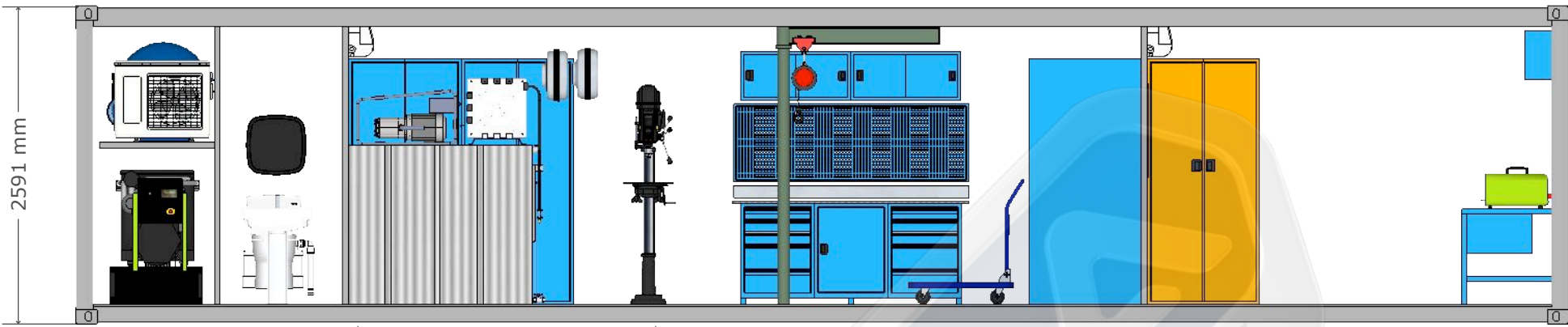

12196 mm

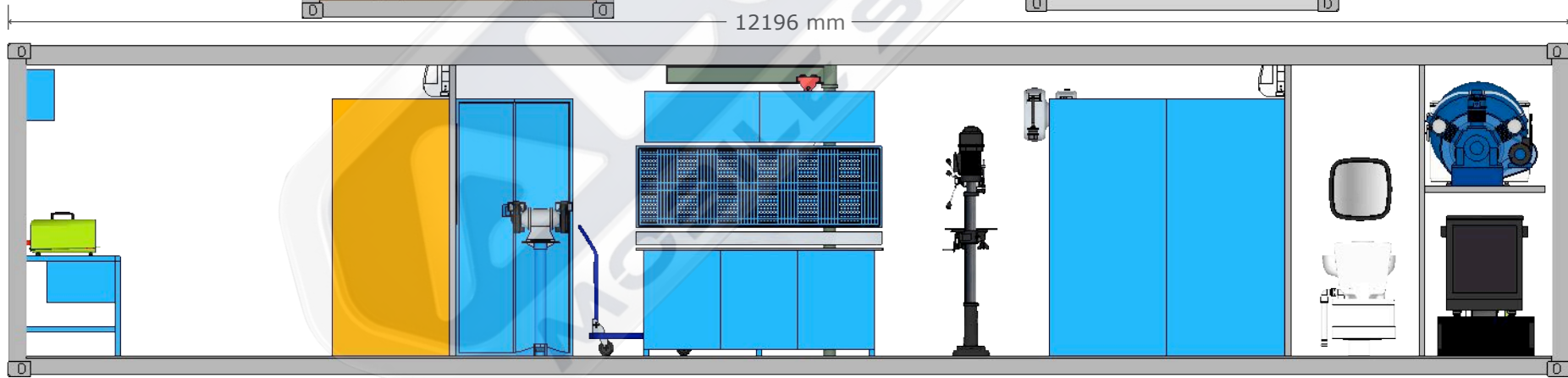

Project / Model
23.026
40 ft Container Service

Info
 40 ft Iso Container

Date : 12.12.2023
 Rev. : 00.00
 Per. : Metin ALÇAR
 Tel. : 0544 242 04 91
 Mail : sales@aluratrailer.com

A 02

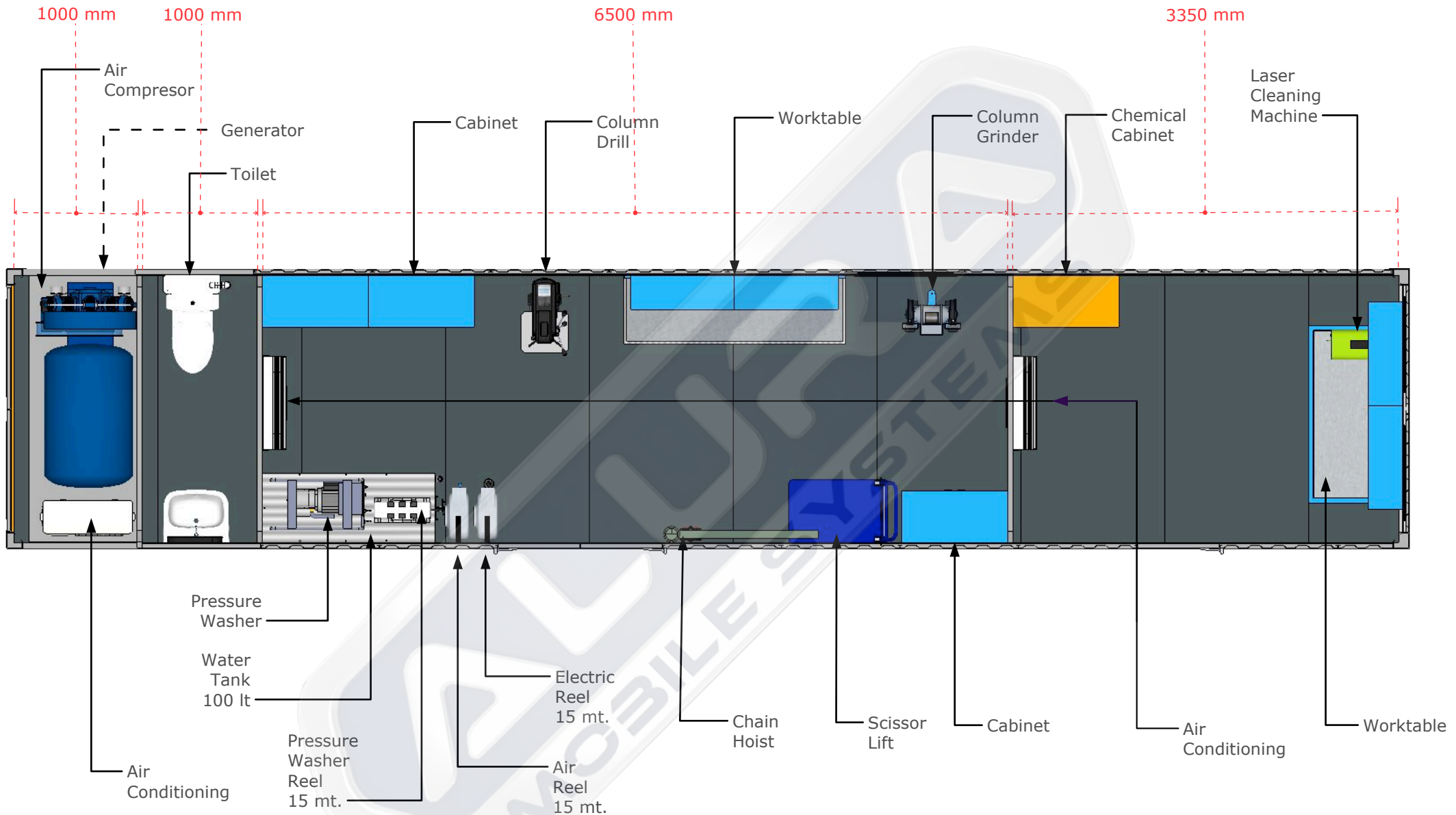

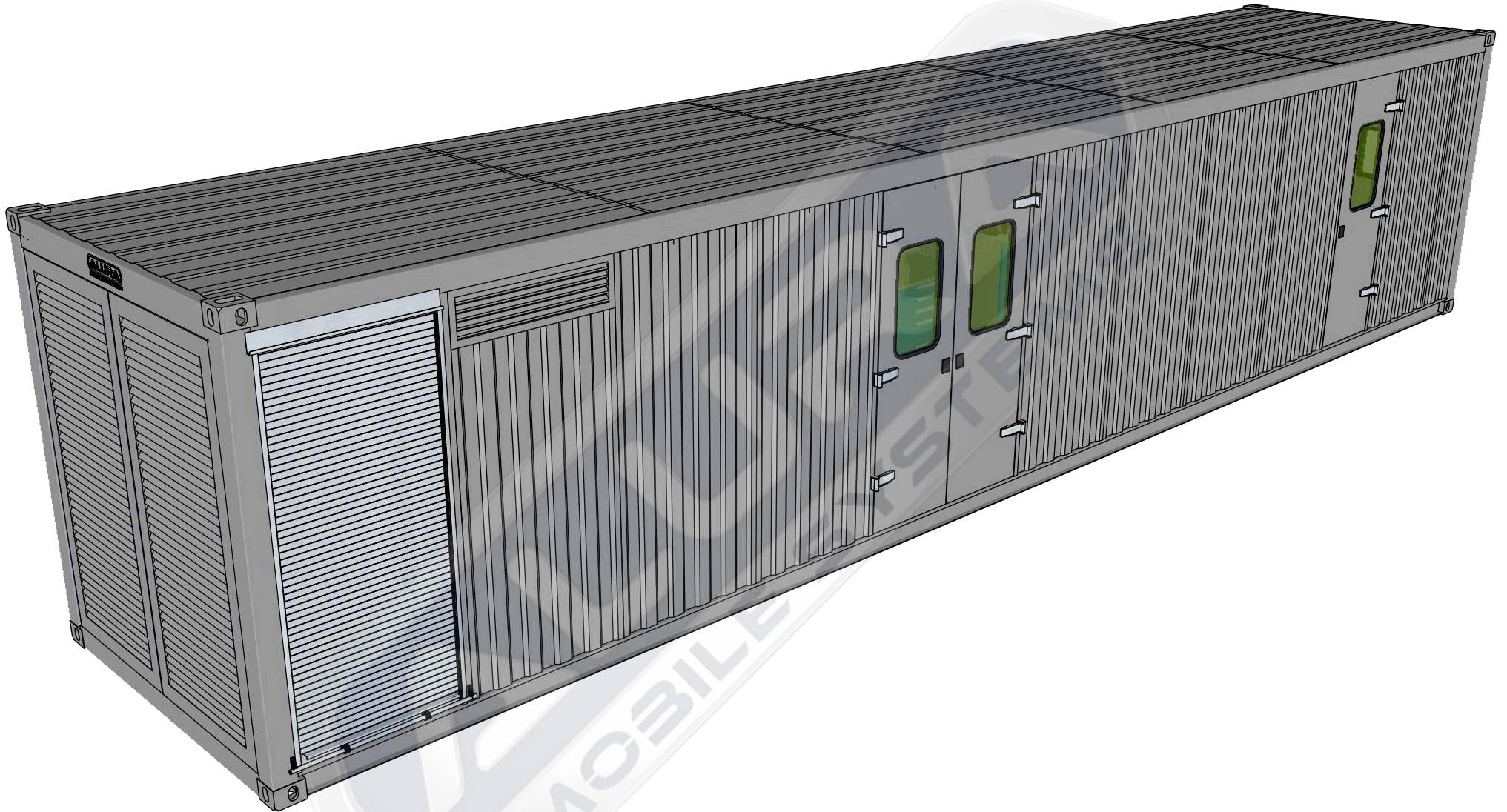

Project / Model

23.026

40 ft Container Service

Info

40 ft Iso Container

Date : 12.12.2023

Rev. : 00.00

Per. : Metin ALÇAR

Tel. : 0544 242 04 91

Mail : sales@aluratrailer.com

A

04

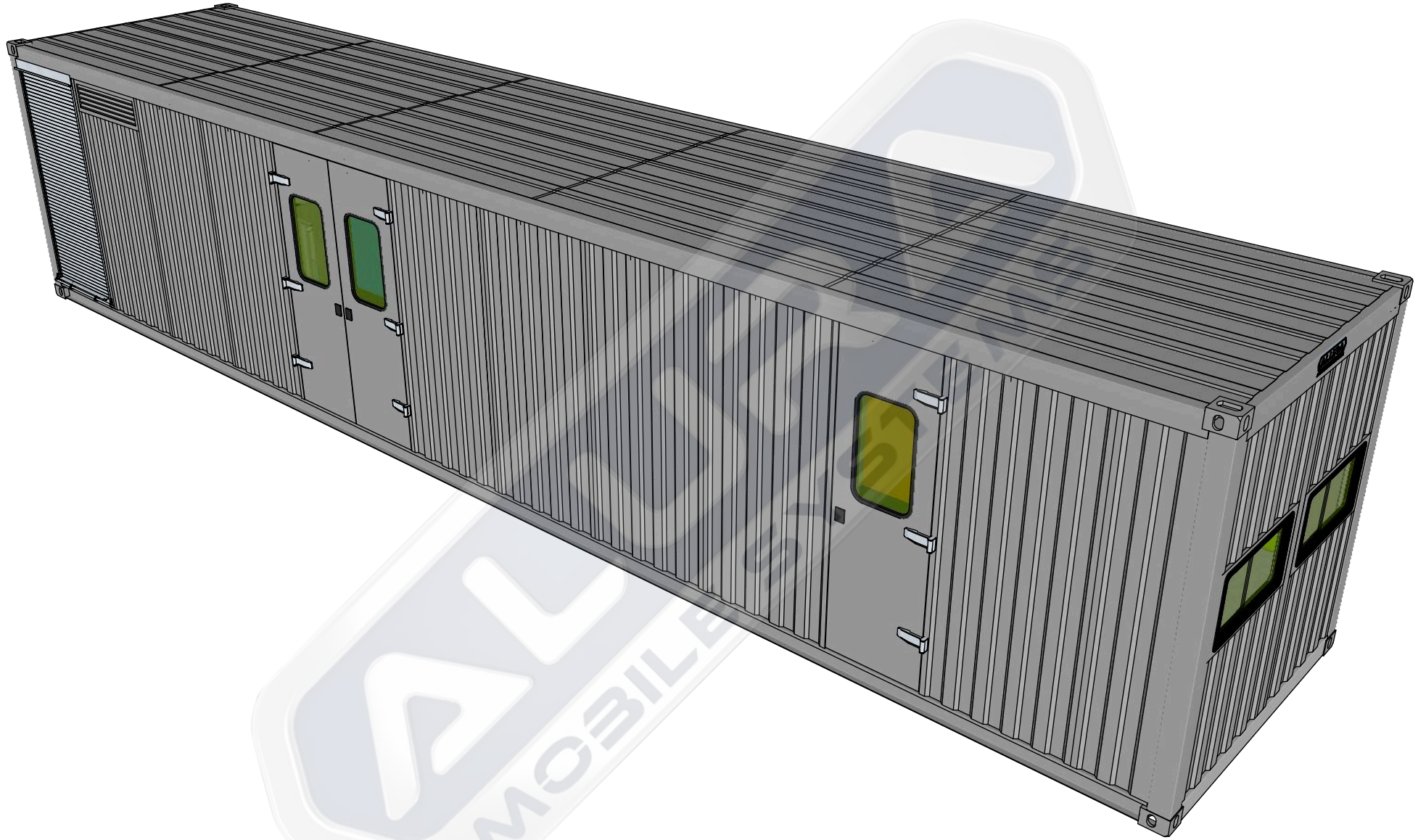

Project / Model

23.026

40 ft Container Service

Info

40 ft Iso Container

Date : 12.12.2023

Rev. : 00.00

Per. : Metin ALÇAR

Tel. : 0544 242 04 91

Mail : sales@aluratrailer.com

A 05

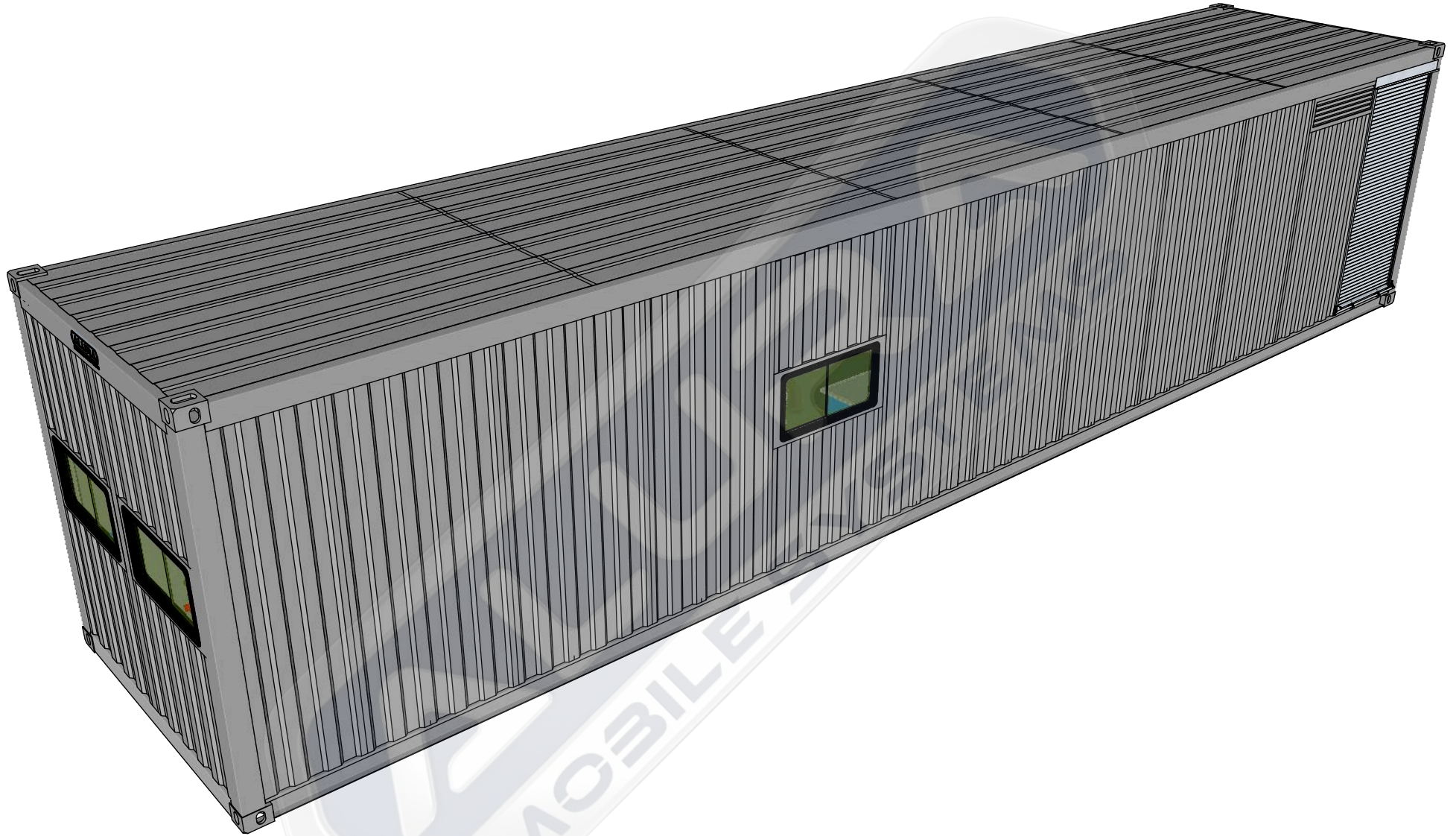

Project / Model

23.026

40 ft Container Service

Info

40 ft Iso Container

Date : 12.12.2023

Rev. : 00.00

Per. : Metin ALÇAR

Tel. : 0544 242 04 91

Mail : sales@aluratrailer.com

A

06

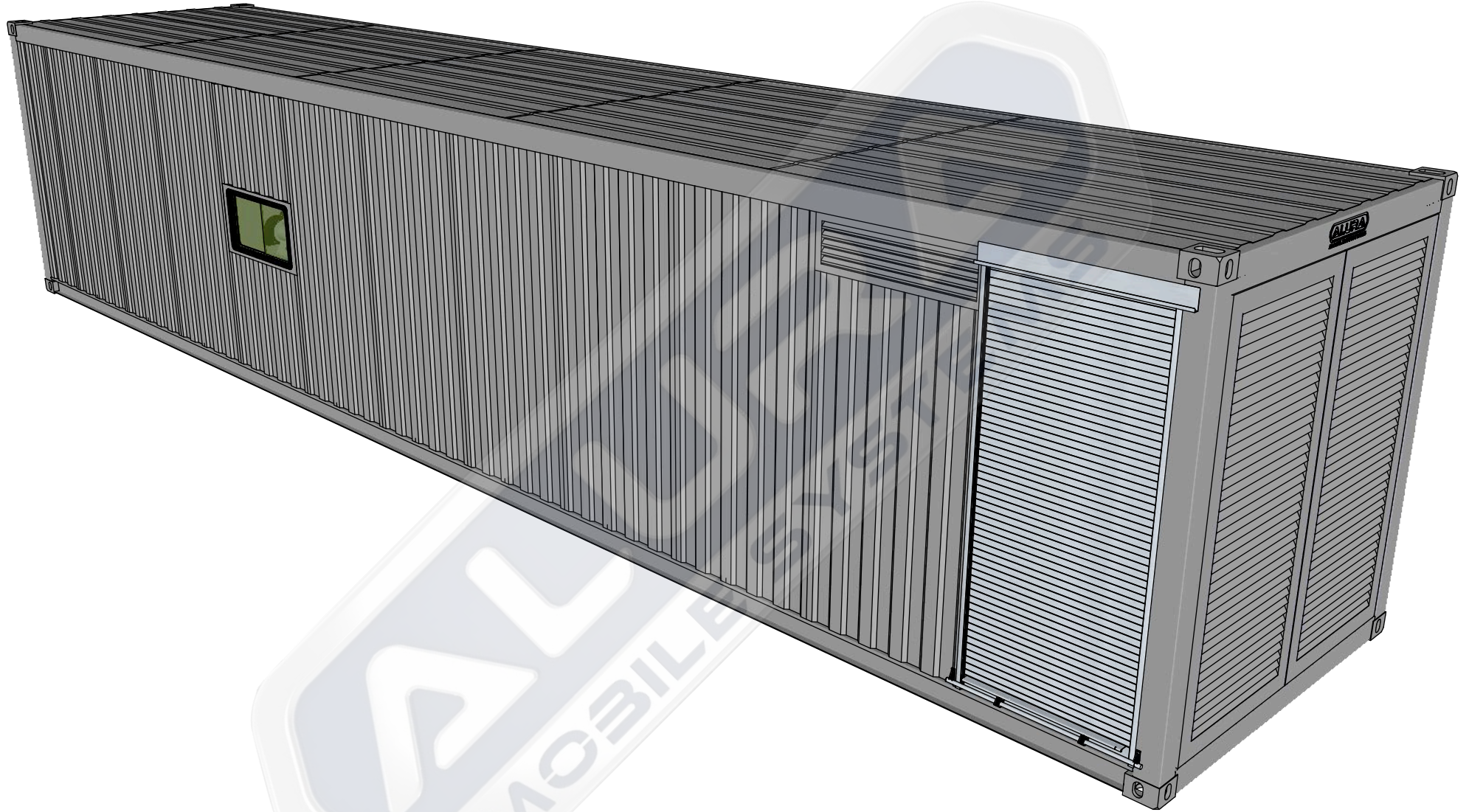

Project / Model

23.026

40 ft Container Service

Info

40 ft Iso Container

Date : 12.12.2023

Rev. : 00.00

Per. : Metin ALÇAR

Tel. : 0544 242 04 91

Mail : sales@aluratrailer.com

A 07

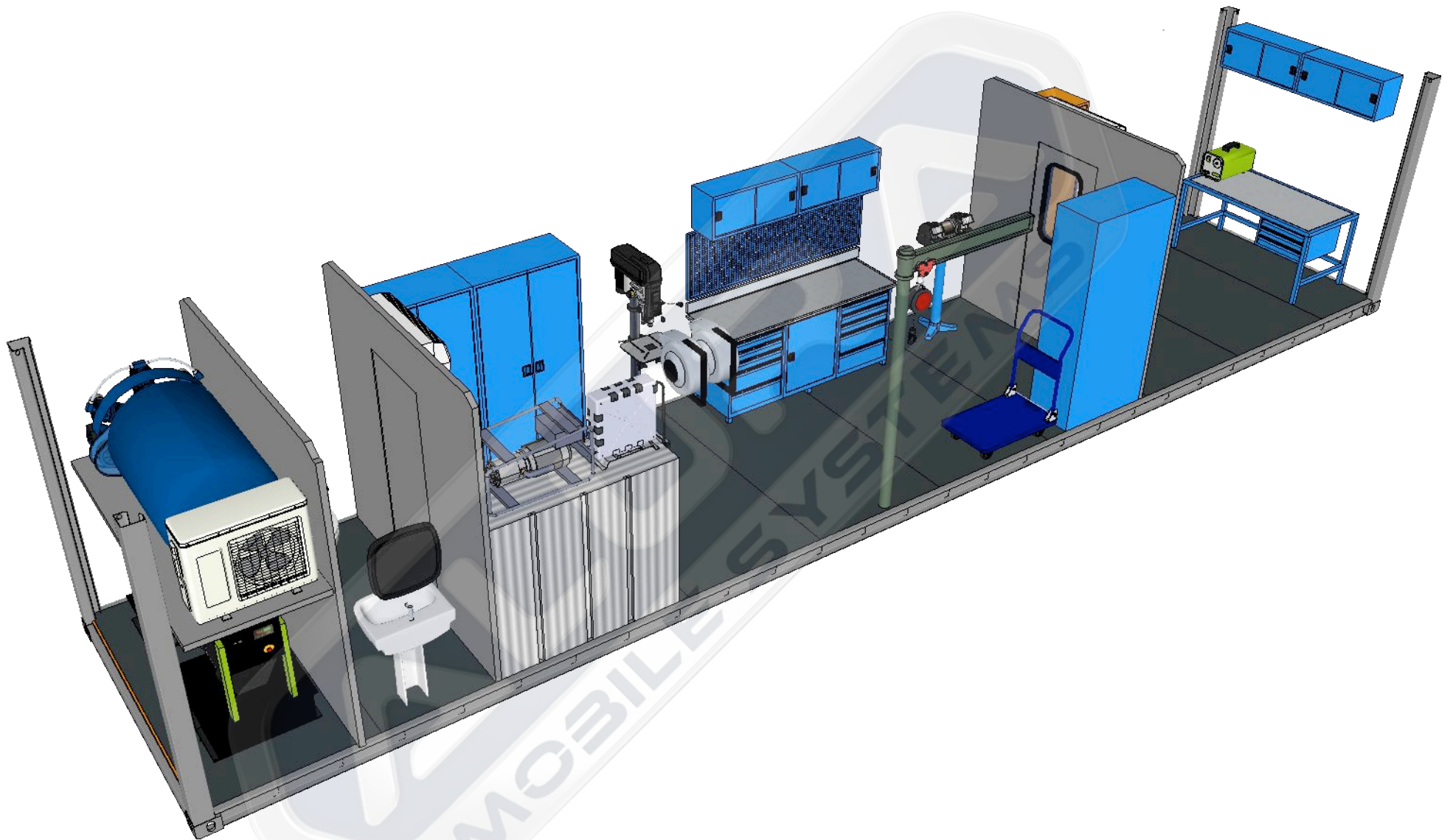

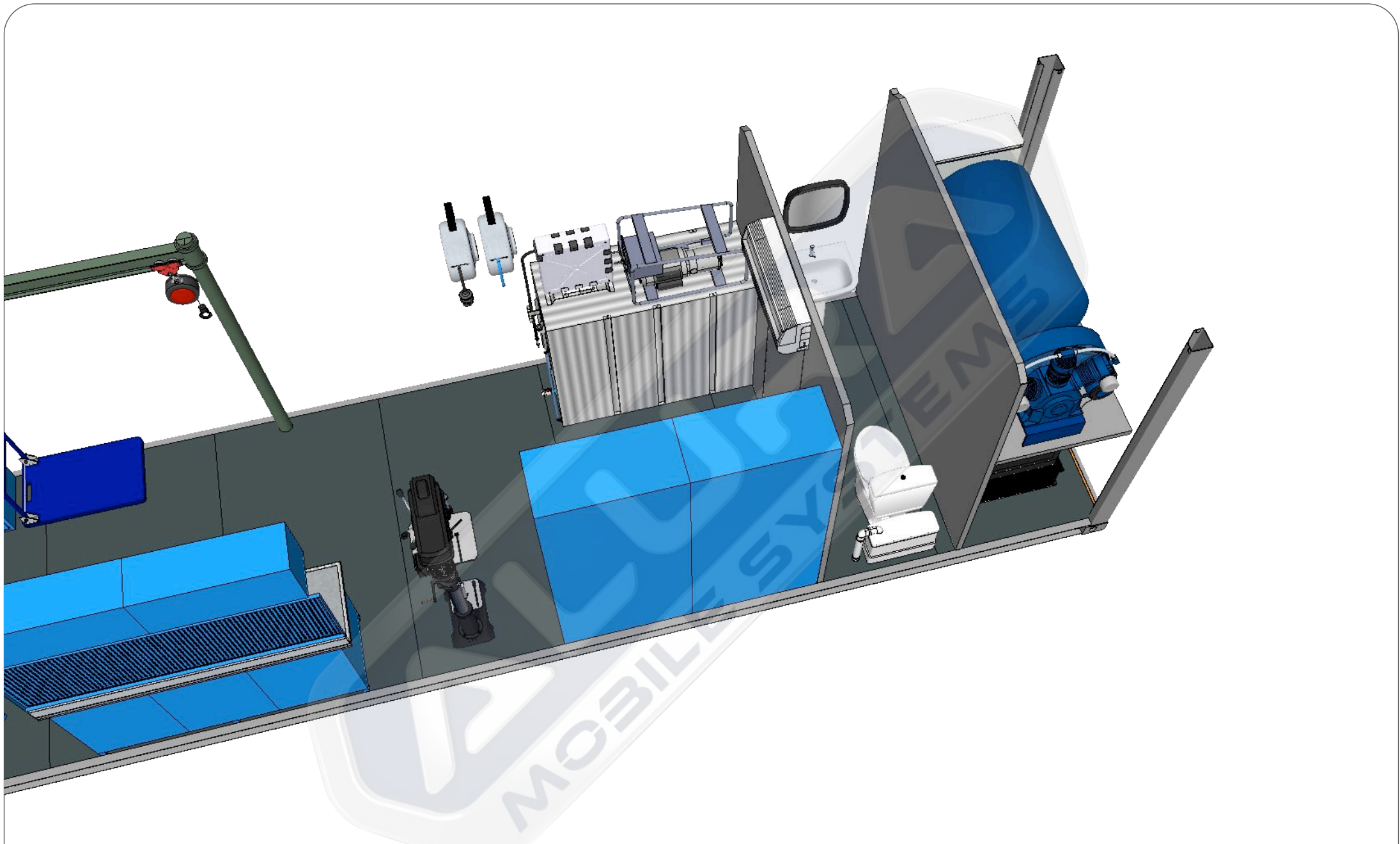

Project / Model
23.026
40 ft Container Service



Info
40 ft Iso Container





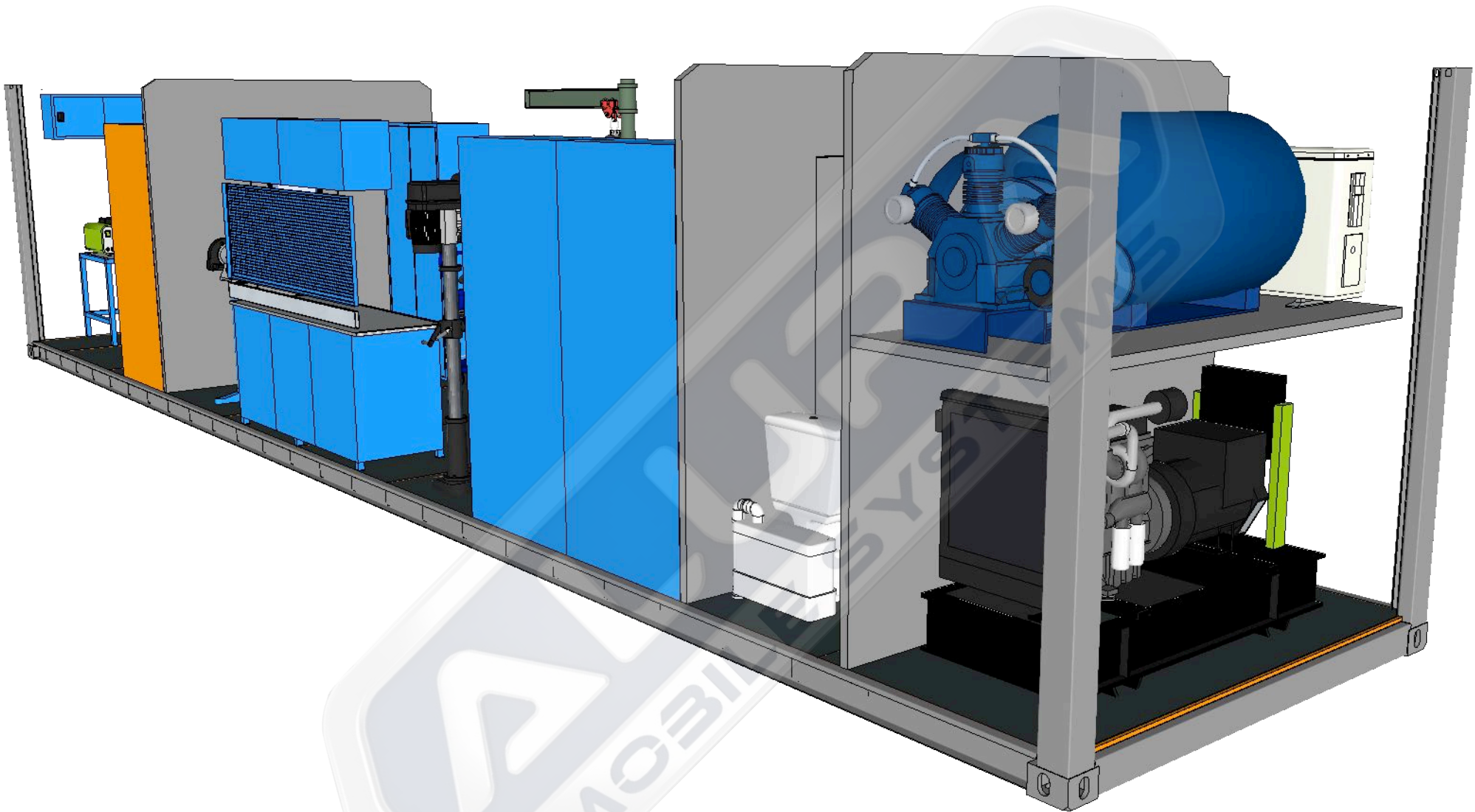

Date : 12.12.2023
Rev. : 00.00
Per. : Metin ALÇAR
Tel. : 0544 242 04 91
Mail : sales@aluratrailer.com





A 09















No	Equipment	Explanation	Producer	Orjin	Piece
1	Bodywork		Alura	Turkey	1
		40' HQ / ISO Container External Dimensions Length: 12.192 mm Width: 2.432 mm Height: 2.896 mm Area : 76.2 m3	Tare: 4.020 kg. Insulation: Polyurethane 30 mm Inner coating: Alukobond 4 mm Floor: Polywood 18 mm Floor Covering: PVC 2,5 mm		
2	Aluminum Shutters		Alura	Turkey	2
		Manuel Working Locking Systems Automatic Rewind Size : 1.000 x 2.300 mm 2 Pcs. 2.000 x 2.300 mm 1 Pcs.			
3	Control panel of all equipment.		Alura	Turkey	1
		Control Panel Generator, compressor, pressure washer, water pump and lighting system control panel.			
4	Control panel of all equipment.		Alarko	Turkey	1
		Cooling Capacity : 18.000 btu Current Cooling : 6.3 / 6.9 A Required Fuse : 7 A Thermostatic Heat Control Yes Refrigerant : R32 Indoor unit : 2 pcs.			
5	Generator Diesel		Power	Turkey	1
		Standby/Prime Power: 22 kVa / 23 kVa Standard Voltage: 230 V / 1 Phase Engine Bran: Perkins Engine Model: 1103A-33TG1 Alternator: Sincron RPM: 1500 rpm.	Frequency: 50 Hz. Water Cooling		
6	Pistone Compressor		Aykom	Turkey	1
		Chassis Piston Air Compressor Engine Power: 5.5 hp Air Intake: 400 lt/min Revolution : 980 rpm Pressure : 8 bar Working Power : 230 V	Aluminum Body Anti-Vibration wedges		

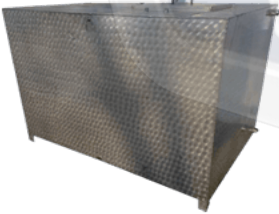

No	Equipment	Explanation	Producer	Orjin	Piece
7	Air Tank		Alura	Turkey	1
		Capacity : 300 lt. Working Pressure: 15 bar. Test Pressure: 15 Bar. Sheet Thickness: 4 mm. Compressor Connection : 1" Air Outlet : 1/2"			
8	Work Bench		Alura	Turkey	1
		Work Bench Width: 1.800 mm Depth: 700 mm Height: 2.000 mm Number of Drawers: 10 Drawer Carrying Capacity: 60 kg.	Shelf Carrying Cap .: 80 kg. Socket 2 Pieces 25 mm MDF + Pvc on worktops Electrostatic powder paint Suspension boards modular		
9	Metal Cabinet		Alura	Turkey	1
		WxDxH: 1.000 x 450 x 2.000 mm Body and carriers 0.80 - 1.2 mm It is long-lasting and durable. The covers are double wing reinforced. Number of Shelves: 7 Pieces Shelf Carrying Cap .: 80 kg.	Variable drawer groups		
10	Metal Cabinet		Alura	Turkey	2
		WxDxH: 1.000 x 450 x 2.000 mm Body and carriers 0.80 - 1.2 mm It is long-lasting and durable. The covers are double wing reinforced. Number of Shelves: 7 Pieces Shelf Carrying Cap .: 80 kg.			
11	Workbench		Alura	Turkey	1
		Wheeled Drawer Width: 600 mm Depth: 465 mm Height: 950 mm Number of Drawers: 6 Pieces Drawer Transport Cap. : 60 kg.			
12	Clamp		izeltaş	Turkey	1
		Cast Body Leveler's Vise : 100 Mm Jaw Spacing : 100 mm Mouth Width: 125 Mm			

No	Equipment	Explanation	Producer	Orjin	Piece
13	Column Drill		Foreman	Taiwan	1
		Drilling Capacity: 16 mm Pinole Diameter: 40 mm Pinole Movement: 80 mm Spindle Column Distance: 163 mm Spindle Tip: MT2 mm Spindle Speeds: 180-2770 rpm	Table Size: 170x175 mm Spindle Table Distance: 725 mm Spindle Base Distance: 1205 mm Engine: 550W Voltage: 220V Weight: 58 kg		
14	Hand Tools Set 62 Pcs		İzeltaş	Turkey	1
		Combination Wrench : 8.9.10.11.12.13.14.17.19.22 Pliers Universal 240 mm : 1 Pc 1/2" Socket Wrench : 10 / 32 Extension Bar Long 250mm : 1 pc Universal Joint 70 mm : 1 pc Ratchet Handle 250 mm : 1 pc Combination Pliers,180 mm : 1 pc Nose Pliers,Flat, 160 mm : 1 pc Side Cutting Nippers, 160 mm : 1 pc	Screwdriver,Opak,Phillips 3x80.4x100.5x125.6x150 : 4 pc Screwdriver,Flat 4.5x80.6x100 : 2 pc Voltage Tester 135 mm : 1 pc Screwdriver, Bit Holder 6.3x30 : 1 pc Bits Set 25 mm : 10 pc Hex Key Wrench Set 2. 2,5. 3. 3,5.4.5.6.7.8.9.10.12 Measuring tapes 5 m : 1 pc		
15	Vernier Caliper		İzeltaş	Turkey	1
		Vernier Caliper 200 mm and micrometer screw gauge Sliding, with Stop Length: 200mm Weight: 175 Gr			
16	Measuring Tape		İzeltaş	Turkey	1
		Measuring Tape 5 m Compact 5mt X 16mm Tape Measure			
17	Grinding Machine		Workman	Taiwan	1
		Grinding Diameter: 200 mm Horsepower: 0.75 HP Voltage: 230 Volts. Speed: 3,000 rpm.			

No	Equipment	Explanation	Producer	Orjin	Piece
18	Laser Cleaning Machine		P-Laser	Belgium	1
		<p>Working Power: 300 W Electricity: 230 V Dimensions: 300x665x465 mm Weight: 30 - 35 kg QFC-200 and QFC-300 are versatile laser cleaning systems.</p>	<p>It is portable and the extendable handle and wheels allow hassle-free transportation. As with every P-Laser system, 8 special jobs can be selected with the rotary wheel on the encoder.</p>		
19	Chemical Material Cabinet		Alura	Turkey	1
		<p>Depth: 615 mm Height: 2000mm Colour: Ral 1028 electrostatic powder coated. The shelves of our chemical cabinet have drawers, and since they are</p>	<p>in the from of a leak-proof pool, they prevent liquid leakage to other shelves.</p>		
20	Chain Hoist		Paftar	Taiwan	1
		<p>Capacity: 1 ton Lifting Height: 5 mt. Movement: 2 Type: Manual</p>			
21	Scissor Platform		Star	Turkey	1
		<p>Capacity: 500 Kg Wheel Diameter: 127 mm Total Length: 925mm Total Height: 970 mm Lift Height: 560 mm Weight: 87 Kg</p>	<p>min. Table Height: 340 mm Max. Table Height: 900 mm Table Dimensions: 855 x 500 x 50 mm Max.For Height,Pedal Presses: 45 mm</p>		
22	Waste Tank		Alura	Turkey	1
		<p>Stainless water tank 2 mm . Capacity: 1.000 ltr. Filling mouth. Flow and dump valve Water filter Fill indicator.</p>			
23	Cold Washing Machine		Alura	Turkey	1
		<p>Pressure: 180 bar Flow rate: 510 lt/hour Engine Power: 4 hp Voltage - Phase 220V-3 50 Hz Weight: 74 kg Spray gun</p>			

No	Equipment	Explanation	Producer	Orjin	Piece
24	Washing Hose Reels		Raasm	Italy	1
		Pressure: 400 bar. Hose Length: 15 mt. Compatible fluids: Water Swivel joint: Stainless Metal Characteristic: Fixed Material: Painted steel			
25	Lighting		EAT	Turkey	6
		Body : Polycarbonate RAL 9003 body , Metal lock clip Diffuser: Polycarbonate opal cover Light Source: Mid Power LED Power: 28 W / 38 W / 55 W Input Voltage: 220-240V - IP 65			
26	Outdoor Lighting		CSR	Turkey	10
		Operating Voltage : 12 / 15 V Current : 1.4A Driving Type: Linear current and voltage controlled driver Light Source: 3W 12pcs power LED LENS Feature: 25° collimator LENS	White:5000-7000K Physical Properties : Polycarbonate plastic black aluminum profile		
27	First-aid kit		First	Turkey	2
		It is mounted on the wall. 30 types of first aid products. Plastic box and wall bracket.			
28	Water Tank		Alura	Turkey	1
		Stainless water tank 2 mm . Capacity: 1.000 ltr. Filling mouth. Flow and dump valve Water filter Fill indicator.			
29	Water Pump		Karcher	Germany	1
		Maximum Motor power : 1000 W Maximum Water Flow: 4500 l/hour Maximum pressure: 50/5 m/bar Working pattern: 1.9 - 3 bar Maximum suction : 8 m Maximum leaving water : 35 °C			

No	Equipment	Explanation	Producer	Orjin	Piece
30	Fire Extinguisher		ASSA	Turkey	3
		ABC Grade Fire Extinguishing Powder 6 Kg Capacity MAP Rate 40% Body made of A1 7114 Quality Plastered Sheet 18 Bar Working Pressure	0.70 Micron Electro Static Paint It Has a Refillable Structure.		
31	Toilet with grinder		SFA	Italy	1
		Type of liquid to be pumped: Septic tank wastewater Connectable units: 1 Sink European standard: EN 120503 Dimensions : 390 x 440 x 445 mm Discharge Port Diameter: 32 mm Voltage: 220 V - 50 Hertz Max vertical head. : 3 meters	Max horizontal head. : 30 meters Engine speed: 800 rpm Engine Power: 550 Watt Horizontal connection slope: 3% Inlet Connection diameter: DN 40 Max. Flow rate : 6 m3/hour Sound Level: 51 dB(A)		
32	Sink Set		Pandora	Turkey	1
		Washbasin with Cabinet Material: Mdf Feature: Bottom module with 2 doors. Upper module: Consists of a cabinet with 2 shelves and a mirror door. Lower Module: WxHxD 45x 55x47 cm	Upper Module: WxHxD 45x55x14.5 cm Base drain - With proper sealing, the base goes away.		
33	Liquid Soap Dispenser		Aqua	Turkey	2
		Its body is aluminum casing. Elbow press, Metal sleeves. The bottle inside is plastic. It has a liquid dispenser mouth. Capacity : 1000ml.			
34	Hand Tools Set 62 Pcs		İzeltaş	Turkey	1
		Combination Wrench : 8.9.10.11.12.13.14.17.19.22 Pliers Universal 240 mm : 1 Pc 1/2" Socket Wrench : 10 / 32 Extension Bar Long 250mm : 1 pc Universal Joint 70 mm : 1 pc Ratchet Handle 250 mm : 1 pc Combination Pliers,180 mm : 1 pc Nose Pliers,Flat, 160 mm : 1 pc Side Cutting Nippers, 160 mm : 1 pc	Screwdriver,Opak,Phillips 3x80.4x100.5x125.6x150 : 4 pc Screwdriver,Flat 4.5x80.6x100 : 2 pc Voltage Tester 135 mm : 1 pc Screwdriver, Bit Holder 6.3x30 : 1 pc Bits Set 25 mm : 10 pc Hex Key Wrench Set 2. 2,5. 3. 3,5.4.5.6.7.8.9.10.12 Measuring tapes 5 m : 1 pc		

No	Equipment	Explanation	Producer	Orjin	Piece
35	Air Regulator		Osaka	Japan	1
		Air Inlet : 1/2" Filter : 20u Working Pressure: 05-9.9 atu Operating Temperature: 5-60°C Water Capacity: 80 ml Air Permeability: 2200 lt/min			
36	Air Line Connection		Osaka	Japan	1
		Polyurethane Pneumatic fittings Polyurethane Hose 7x10 mm			

