

Project / Model  
**21.028**  
**40' Repair Service Container**

Explanation  
40' HQ ISO Container

Info  
Date : 12.08.2021  
Rev. : 02 - 18.08.2021  
Per. : Metin ALCAR  
Tel : 0544 242 04 91  
Mail : sales@aluratrailer.com

**A 01**

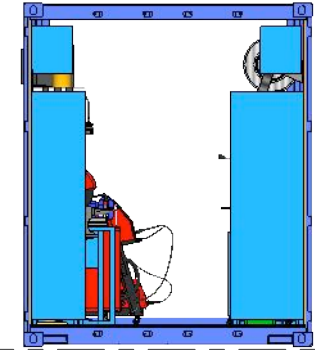
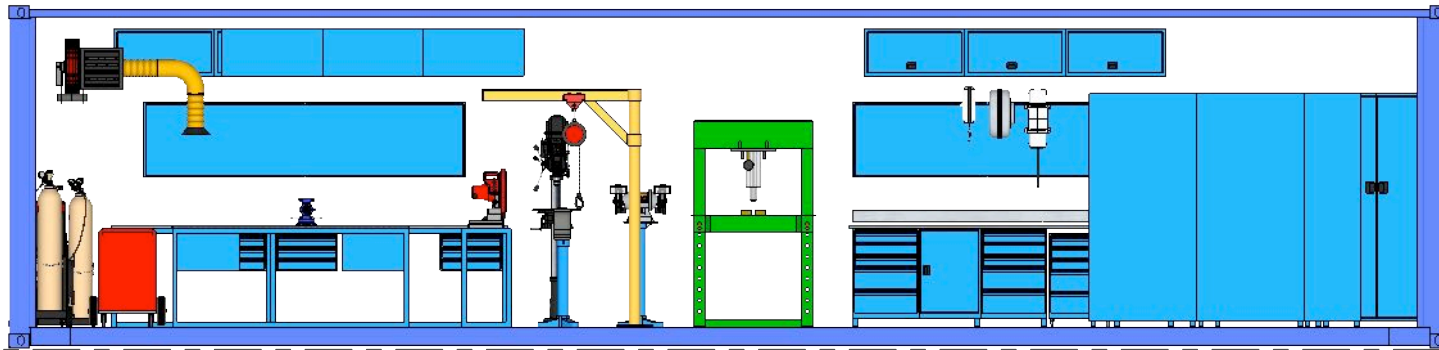
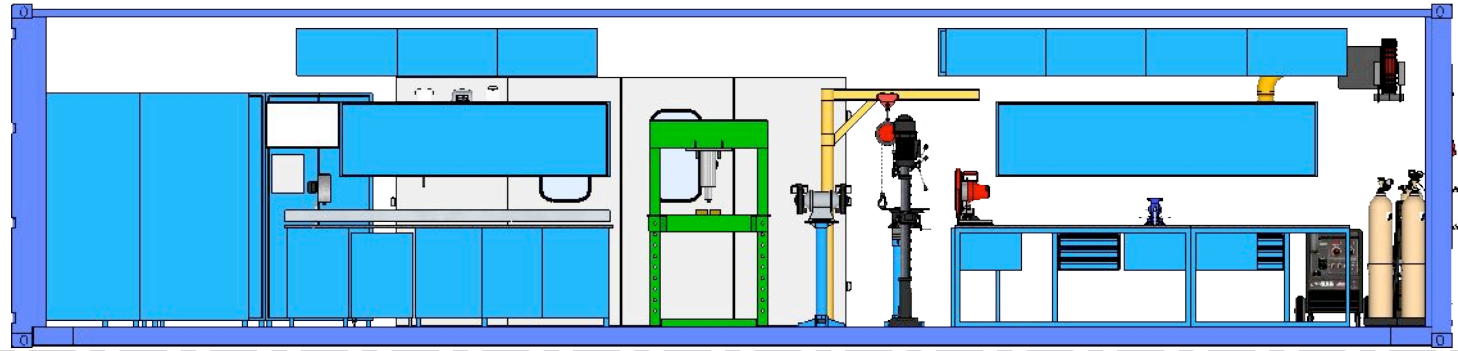
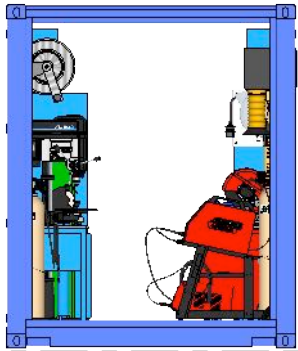

Project / Model  
**21.028**  
**40' Repair Service Container**

Explanation  
 40' HQ ISO Container

Info  
 Date : 12.08.2021  
 Rev. : 02 - 18.08.2021  
 Per. : Metin ALCAR  
 Tel : 0544 242 04 91  
 Mail : sales@aluratrailer.com

**A 02**

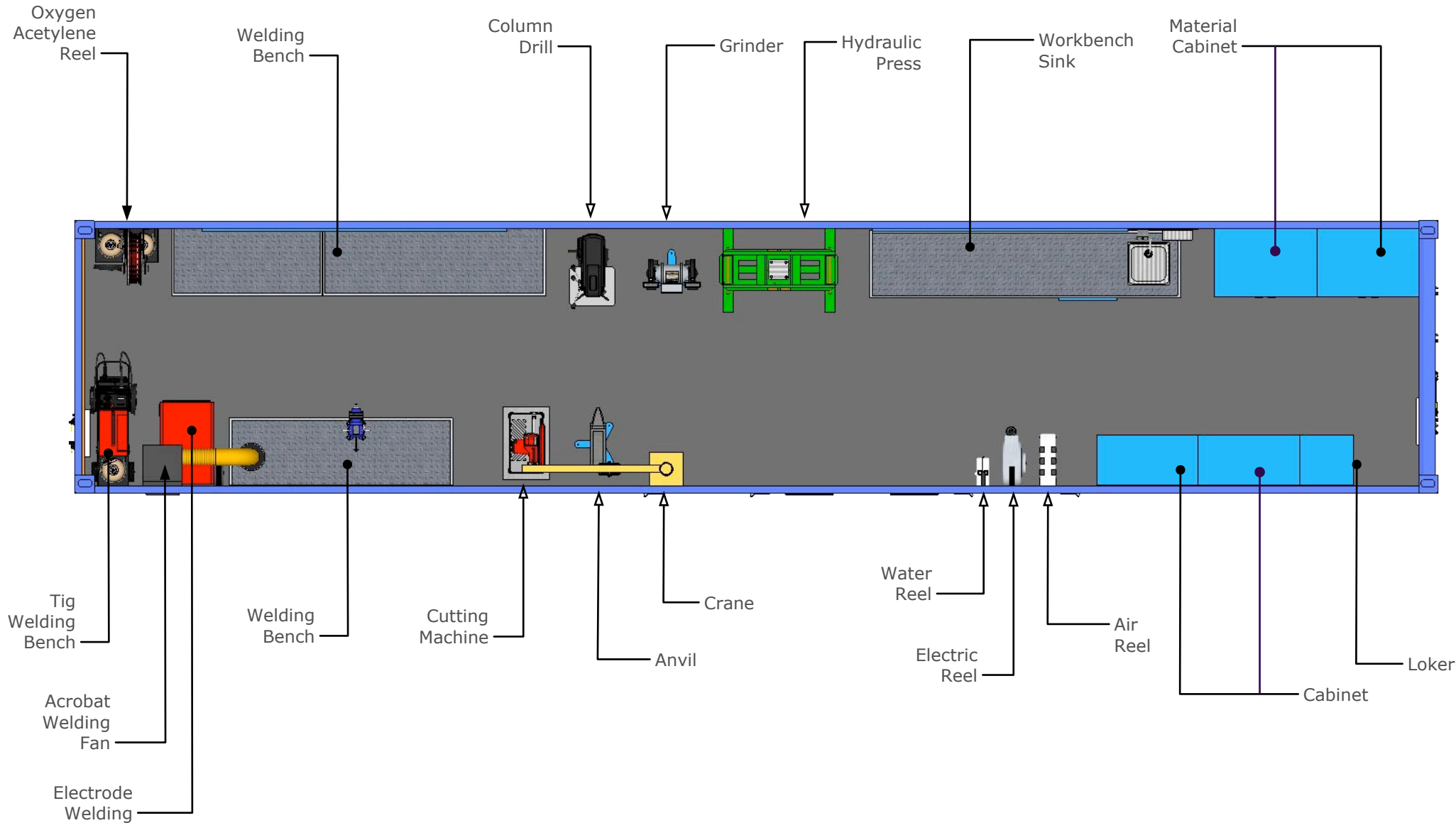

Project / Model  
**21.028**  
**40' Repair Service Container**

Explanation  
 40' HQ ISO Container

Info  
 Date : 12.08.2021  
 Rev. : 02 - 18.08.2021  
 Per. : Metin ALCAR  
 Tel : 0544 242 04 91  
 Mail : sales@aluratrailer.com

**A 03**

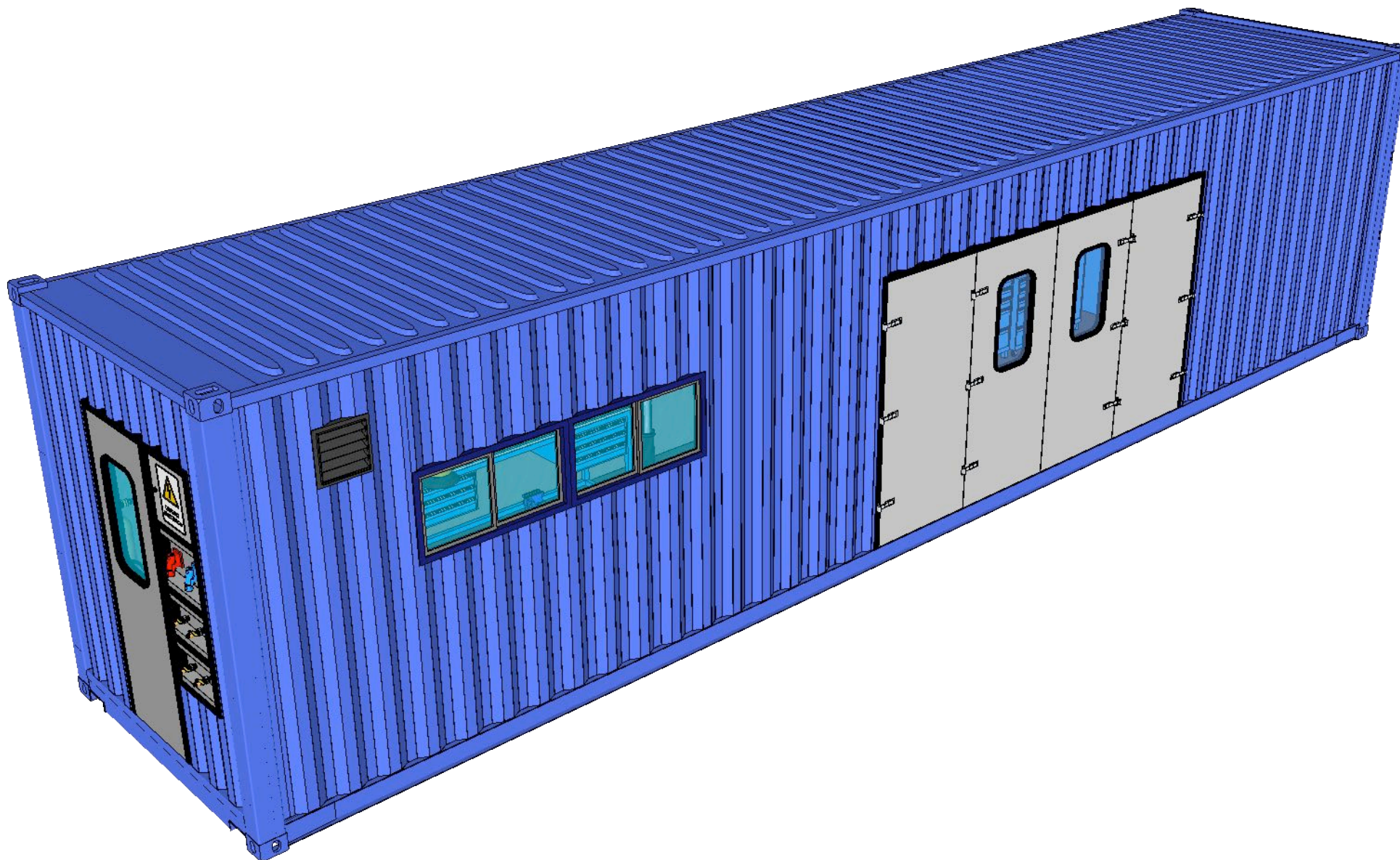

Project / Model  
**21.028**  
**40' Repair Service  
Container**

Explanation  
40' HQ ISO Container

Info  
Date : 12.08.2021  
Rev. : 02 - 18.08.2021  
Per. : Metin ALCAR  
Tel : 0544 242 04 91  
Mail : sales@aluratrailer.com

**A 04**



Project / Model  
**21.028**  
**40' Repair Service  
Container**

Explanation  
40' HQ ISO Container

Info  
Date : 12.08.2021  
Rev. : 02 - 18.08.2021  
Per. : Metin ALCAR  
Tel : 0544 242 04 91  
Mail : sales@aluratrailer.com

**A 05**

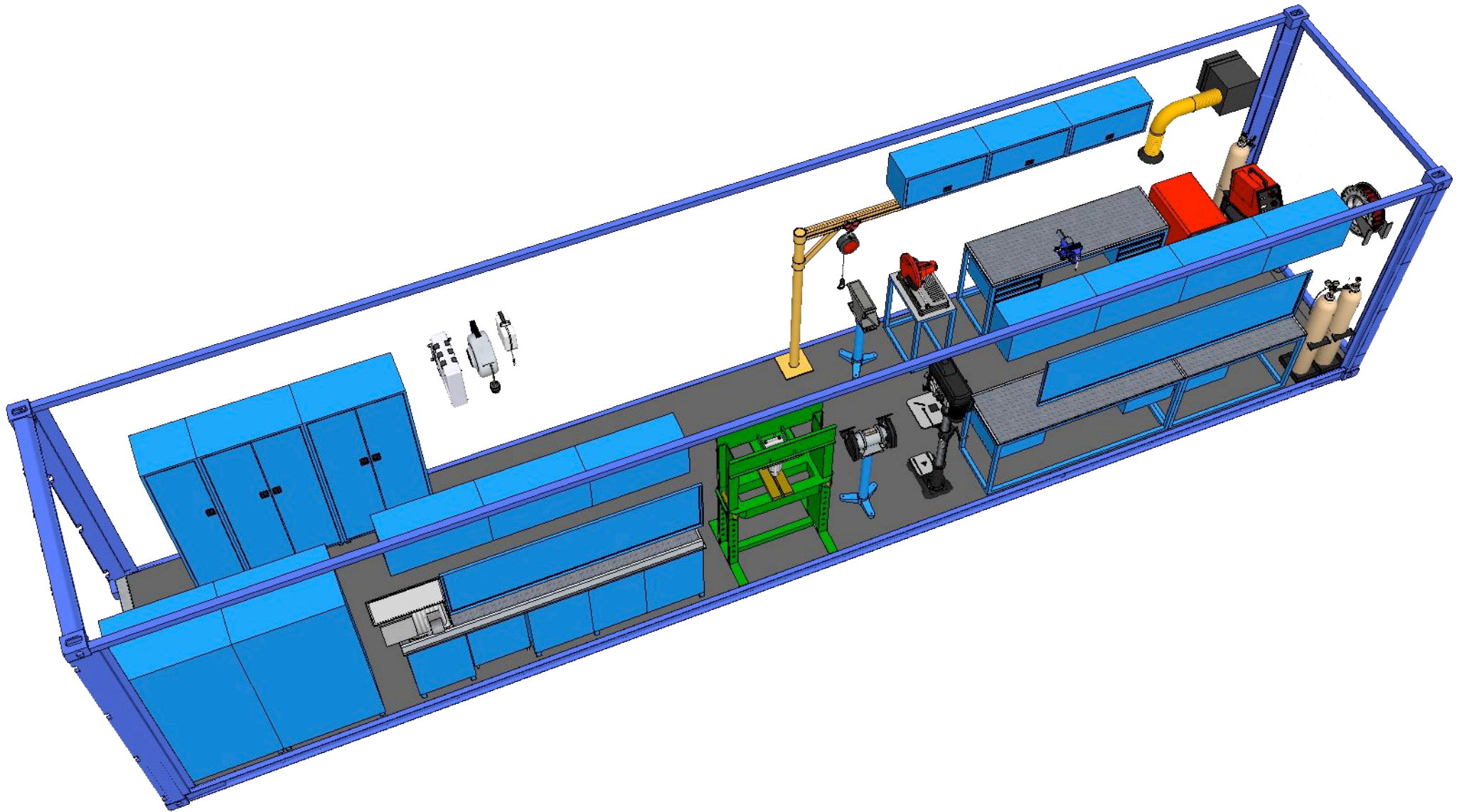

Project / Model  
**21.028**  
**40' Repair Service Container**

Explanation  
 40' HQ ISO Container

Info  
 Date : 12.08.2021  
 Rev. : 02 - 18.08.2021  
 Per. : Metin ALCAR  
 Tel : 0544 242 04 91  
 Mail : sales@aluratrailer.com

**A 06**

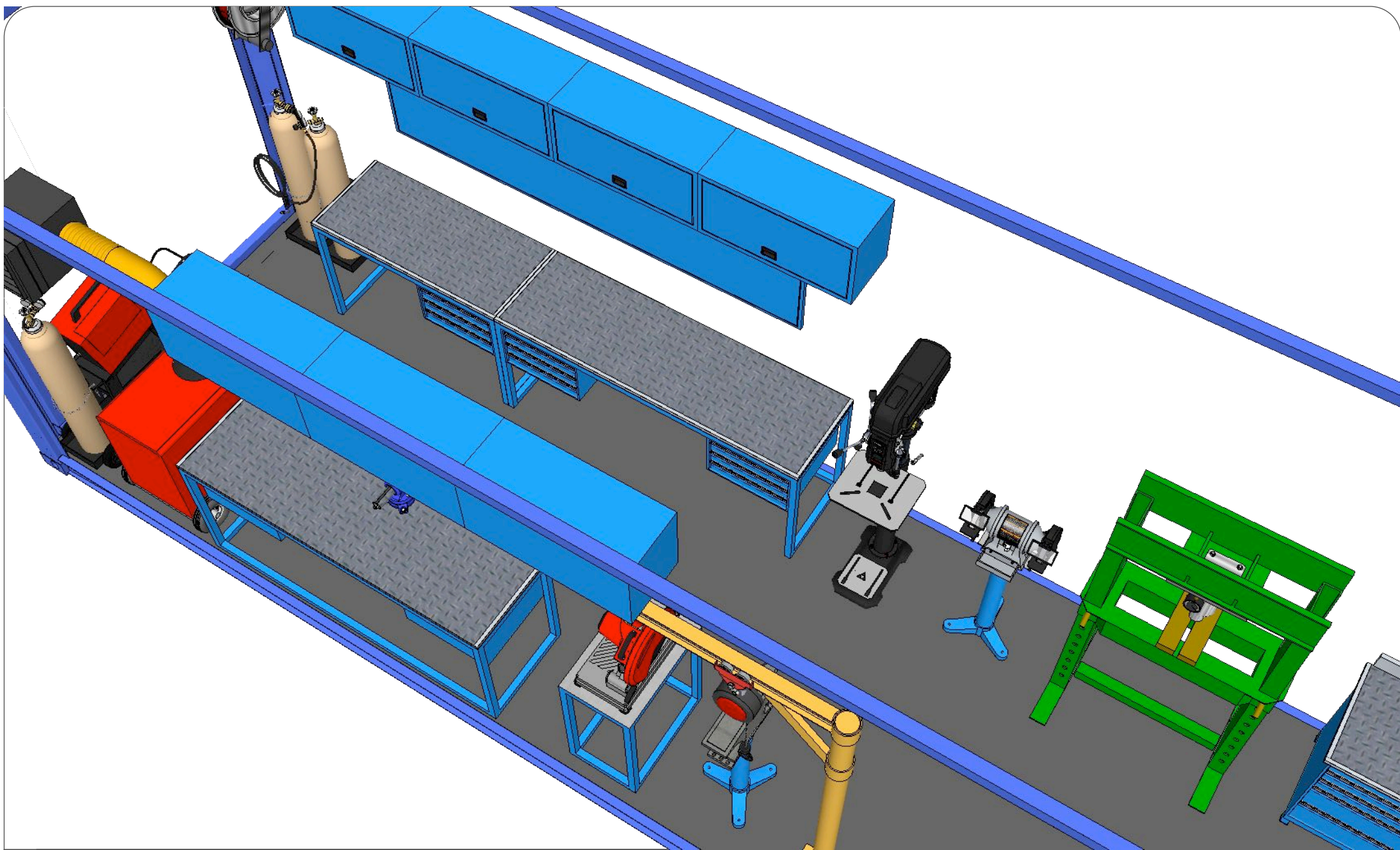

Project / Model  
**21.028**  
**40' Repair Service Container**

Explanation  
 40' HQ ISO Container

Info  
 Date : 12.08.2021  
 Rev. : 02 - 18.08.2021  
 Per. : Metin ALCAR  
 Tel : 0544 242 04 91  
 Mail : sales@aluratrailer.com

**A 07**

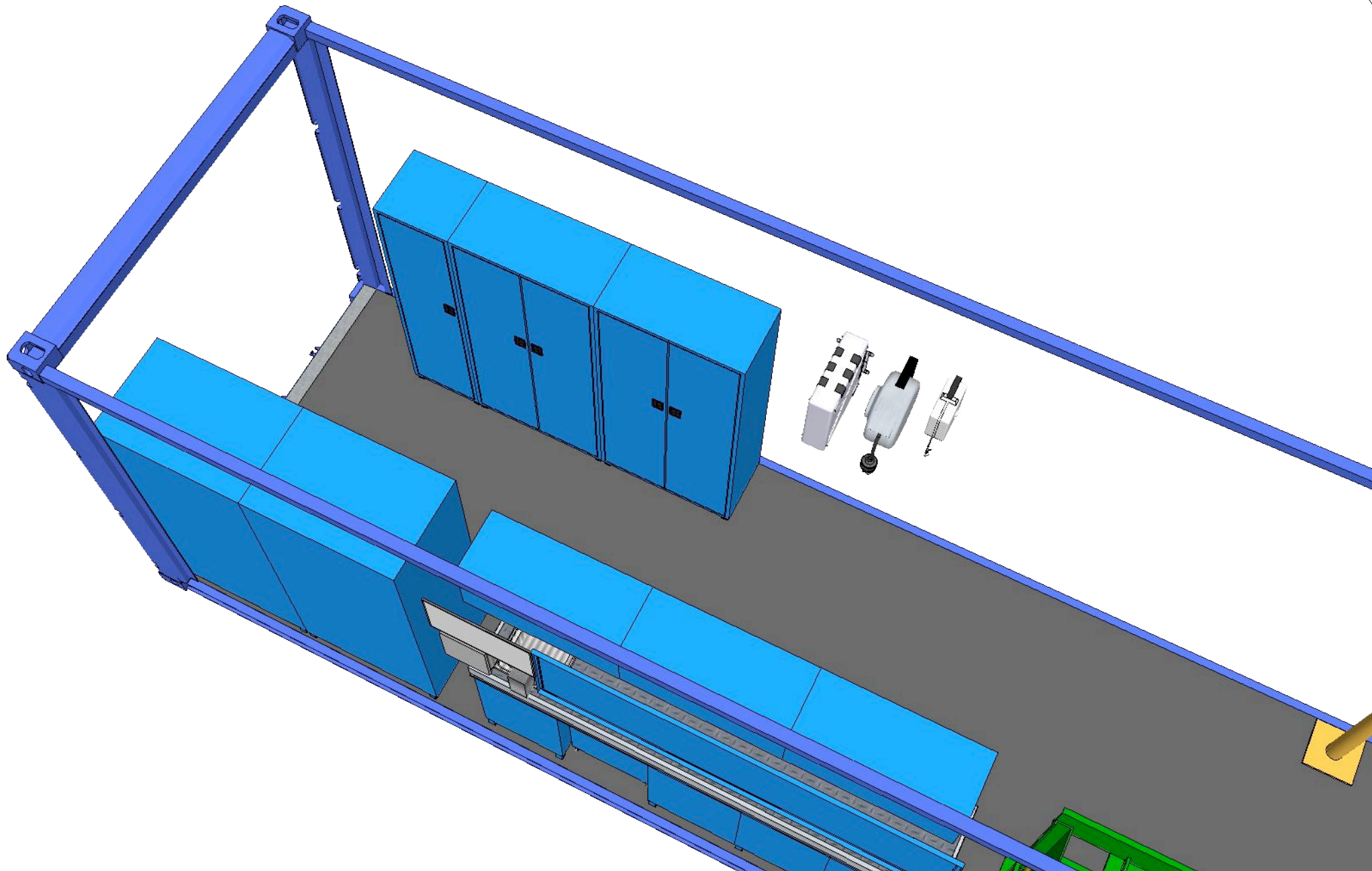





Project / Model  
**21.028**  
**40' Repair Service Container**





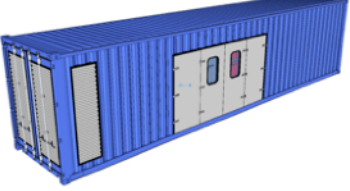

Explanation  
 40' HQ ISO Container



Info  
 Date : 12.08.2021  
 Rev. : 02 - 18.08.2021  
 Per. : Metin ALCAR  
 Tel : 0544 242 04 91  
 Mail : sales@aluratrailer.com

**A 08**





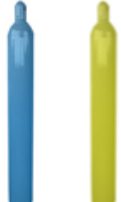



Equipment	Explanation	Brand / Orjin	Quantity	
	<b>Bodywork</b> 40' HQ / ISO Container External Dimensions Length: 12.192 mm Width: 2.432 mm Height: 2.896 mm Internal Dimensions Length: 12.024 mm Width: 2.350 mm Height: 2.697 mm Area : 76.2 m3 Tare: 4.020 kg. Insulation: Polyurethane 30 mm Inner coating: Alukobond 4 mm Floor: Polywood 18 mm Floor Covering: PVC 2,5 mm	ALURA / Turkey	1	pcs
	<b>Work Bench</b> Width: 2.250 mm Depth: 700 mm Height: 2.000 mm Number of Drawers: 10 Drawer Carrying Capacity: 60 kg. Shelf Carrying Cap .: 80 kg. Socket 2 Pieces 25 mm MDF + Pvc on worktops Telescopic rails with 100% opening in drawers Central locking system in drawers Electrostatic powder paint Suspension boards modular Standard 2 220V sockets in electrically connected workbenches	ALURA / Turkey	4	pcs
	<b>Industrial Cabinet</b> Drawers: 8 Height Adjustable Shelves: 3 Width : 1010 mm Depth : 615 mm Height : 2.000 mm These are leaf door, heavy load cabinets. They are welded, stabşe 1.20 mm sheet constructions. Electrostatic powder coated. There are round edged, embedded stripe channel, eloxal aluminium lugs and there are plastic taps on the lug heads.	ALURA / Turkey	2	pcs
	<b>Workbench</b> Wheeled Drawer Width: 600 mm Depth: 465 mm Height: 950 mm Number of Drawers: 6 Pieces Drawer Transport Cap. : 60 kg.	ALURA / Turkey	1	pcs
	<b>Metal Cabinet</b> Width: 1.000 mm Depth: 450 mm Height: 2000 mm Number of Shelves: 7 Pieces Shelf Carrying Cap .: 80 kg. Variable drawer groups Body and carriers 0.80 - 1.2 mm sheet metal It is long-lasting and durable. The covers are double wing reinforced.	ALURA / Turkey	2	pcs







Equipment	Explanation	Brand / Orjin	Quantity	
	<b>Metal Cabinet</b> Metal Locker 1 Person Width : 800 mm Depth : 400 mm Height : 2.100 mm These are leaf door. They are welded, stabşe 1.20 mm sheet constructions. Electrostatic powder coated. There are round edged, embedded stripe channel, eloxal aluminium Lugs and there are plastic taps on the lug heads.	ALURA / Turkey	1	pcs
	<b>Ventilation</b> Case Size: 560 X 560 mm Depth: 260 mm. Blade Diameter: 22 inch. Blade Material: Galvanized Engine Power: 0.34 hp. Air Flow: 9.000 m3 / h-PA	ALFAN/ Turkey	1	pcs
	<b>Smoke Suction Fan</b> 3 Mt Wall Mounted Acrobat Arm FB PRO MIN SERIES acrobat arms, thanks to their flexible - mobile structure, allow dust, smoke and particle emissions to be caught at the point where they are released, without spreading to the environment. Hose options with different specifications for various powder types.	ALFAN/ Turkey	1	pcs
	<b>Welding Machine</b> Coated Electrode Enabling Rate : 250 A, 40% Voltage / Frequency : 220 /230 V 50/60 Hz Power : 8.7 Kw Welding Ampere Range : 10-250 A Dimensions : 285x190x420 Weight : 9.3 kg Electrode Diameter : 1,6-5 Ø Accessories: 6 m. welding pliers, 6m.	BLUWELD / Italy	1	pcs
	<b>Water Cooled Gas Welding Machine MIG/MAG</b> Mains Voltage: 3 Phase, 50/60 Hz, 380 V Installed Power: 17.6 kVa Delayed Fuse: 42 A Idle Operating Voltage: 13-43 V Output Current Range: 30-420 A Duty Rate (40°C) 100% 45% 280 / 360 / 420 Standards: EN 60974-1 / EN 60974-5 Protection class: 23 NP Insulation Class: H Dimensions: 1075 / 500 / 800 mm L*W*H Weight: 162 kg	GEKAMAC/ TURKEY	1	pcs
	<b>Welding Machine</b> Welding Machines: RKM 350 Input Power: 380 / 60 hz Installed Power:15 kVa Fuse: 42 A Current Range: 5 - 300 A Weight: 101 kg	GEKAMAC/ TURKEY	1	pcs















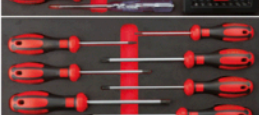

Equipment	Explanation	Brand / Orjin	Quantity	
	<b>Oxygen Pressure Regulator</b> Acet.- With Protection: 1 pc. Shank: 1 pc. Cutting Torch: 1 pc. Acetylene Cutting Nozzles: 1 pc. Welding Attachment No: 4 : 1 pc. Flashback Arrester for Torch - Fuel Gas : 1 pc. Flashback Arrester for Torch- Oxygen : 1 pc. Nozzle Cleaner : 1 pc. Spark Lighter : 1 pc. Oxygen Welding Goggles : 1 pc. Welding Gloves : 1 pcs. Light : 1 pc - 9 leds and 3 pcs batteries Plastic Kit : 1 pc Plastic Kit	YILDIZ / Turkey	1	pcs
	<b>Welding Oxy - Acetylene</b> Fixed hose reel For welding 20 bar Without hose Arrangement for double inlet-outlet. Inlet-outlet G 3/8" (m) Hose 15 mt	RAASM / Italy	1	pcs
	Acetylene & Oxy Cylinder	HABAS / Turkey	1	pcs
	<b>Stainless Water Tank</b> Metal Prisma Tank 2 mm / 500Lt.	ALURA / Turkey	1	pcs
	<b>Air Reel</b> Pressure: 20 bar. Compatible fluids: Air Swivel joint: Stainless Metal Seals: Polyurethane Characteristic: Fixed Material: Painted steel Inlet: G 1/2 " (f) Outlet: G 1/2 "(f) Reel flow path: Zinc plated steel Internal drum width: 110 mm  Single row steel wire braid with high tensile strength High resistance to oil and wear Operating temperature -40 C / +100 C Size: 1/2 " Pressure: 10 bar Length: 25 mt.	RAASM / Italy	1	pcs
	<b>Air Reel Set</b> Professional Blow Gun	AIGNEP	1	pcs

Equipment	Explanation	Brand / Orjin	Quantity	
	<p><b>Water Transfer Set</b>  Length hose : 11 mt.  Length hose con. : 1,5 mt  Hose diameter : 8x12 mt.  Inlet connection thread : G 1/4"  Max working pressure : 10 bar</p>	RAASM / Italy	1	pcs
	<p>Electric Reel  415 VAC 3 phase - 240 VAC 1 phase  Auto Loopback  Thermoplastic Cable  4 socket outlet  240 VAC 3 pcs  380 VAC 1 pcs</p>	ZECA / Italy	1	pcs
	<p><b>Hand Drill</b>  Drilling Machine:710 W  Rated power input: 365 W  Power output: 3-16 mm  Bore Range :2,4 kg  Weight: 1000 / 3000 rpm</p>	BOSCH / Germany	2	pcs
	<p><b>Drill Bit</b>  M6 - M 16 Drilling Set</p>	BOSCH / Germany	2	pcs
	<p><b>Hand Grinding Machine Small</b>  Cutting Machine  Rated power input: 720 W  No-load speed: 500 rpm  Grinding spindle thread: M 14  Main handle Straight  Disc diameter: 115 mm  Weight 1.9 kg</p>	BOSCH / Germany	2	pcs
	<p><b>Hand Grinding Machine Big</b>  Cutting Machine  Rated power input: 2.200 W  No-load speed: 500 rpm  Grinding spindle thread: M 14  Main handle: Straight  Disc diameter: 180 mm  Weight: 5,0 kg</p>	BOSCH / Germany	1	pcs
	<p><b>Table Top Grinder</b>  Disc diameter 200 mm  Idle speed 295 rpm  Disc widths 25 mm  Disc hub diameter 32 mm  Input power 220 W</p>	EINHELL / Germany	1	Ad.

Equipment	Explanation	Brand / Orjin	Quantity	
	<b>Battery Charger</b> Single Phase Mains Voltage 230 V Mains Frequency 50 / 60 Hz Charge Power 1 Kw Start Power 6,4 Kw Charging Voltage 12 / 24 V Effective Charging Current 45 A Rated Charge Curr. 30 A Start Current 1V/C 180 A Max Starting Current 300 A Min. Rated Reference Capacity 20 Ah Max Rated Reference Capacity 700 Ah	TELWIN / Germany	1	pcs
	<b>Hydraulic &amp; Pneumatic Jack</b> Folding Arm Mobile Jack Lifting Capacity: 40/25 tons Min. Height: 180 mm Mak. Height: 273 mm Lifting Distance: 40 / 85-25 / 80 mm Weight: 58 kg	GEMESA / Turkey	1	pcs
	<b>Scissor Platform</b> Capacity: 500 Kg Wheel Diameter: 127 mm Total Length: 925mm Total Height: 970 mm Lift Height: 560 mm Weight: 87 Kg min. Table Height: 340 mm Max. Table Height: 900 mm Table Dimensions: 855 x 500 x 50 mm Max. For Height, Number of Pedal Presses: 45 mm	ATLAS / Kore	1	pcs
	<b>Jack Stand</b> Capacity: 6 / 12 Ton. Lifting Height: 450 / 600 mm.	ATEK / Turkey	4	pcs
	<b>Workshop Hydraulic Jack</b> Capacity: 2 tons System: Manual Hydraulic Pump Model: Folding Dimensions: 2.000x2.000x2.800 mm Weight: 200 kg.	BASARAN / Turkey	1	pcs
	<b>Fixed Iron Cutting</b> Metal Cut-Off Saw GCD 12 JL Professional 1 X Circular saw blade Expert for steel, 305 x 25.4 x 2.6 mm, 60 Voltage 240 V	BOSCH / Germany	1	pcs

Equipment	Explanation	Brand / Orjin	Quantity	
	<b>Hydraulic Press</b> Capacity 25 ton 220 V Electric Motor Oil Pressure Gauge Pressure Adjustment / User Manual Stroke: 170 mm A: 1780 mm B: 750 mm C: 750 mm D: 490 mm E: 200 mm H: 700 mm	SAHINLER / Turkey	1	pcs
	<b>Chain Crane</b> Capacity 1000 Kg. Chain 5 mt.	ATLAS / Kore	1	pcs
	<b>Clamp</b> Size : 150 mm Jaw Width : 150 mm Total Lenght : 420 mm Arvil Size : 70x100 mm Vice Heaighy : 170 mm	GAMA / Turkey	2	pcs
	<b>Auto Creeper</b> 91cm long, heavy duty plastic sled Six non-destructive, oil resistant, wide wheels for easy maneuverability Oil-resistant padded headrest for comfortable handling Integred toolboxes on both sides of the blade for easy access 910x430x110mm	TROY / Italy	2	pcs
	<b>Lighting</b> Body : Polycarbonate RAL 9003 body , Metal lock clip Diffuser: Polycarbonate opal cover Light Source: Mid Power LED Consumption Power: 28 W / 38 W / 55 W Input Voltage: 220-240V AC 50/60 Hz CRI: >80 IP Value: IP65 Usage: Surface Mounted	EAE / Turkey	8	pcs
	Control panel of all equipment. Generator / Mains power connection.	ALURA / Turkey	1	pcs
	<b>Fire extinguisher</b> Capacity: 6 kg. Full Weight: 9.1 kg. Working Pressure: 18 bar. Discharge Time: 14 sec. Extinguishing Agent: MAP@ (ABC)	ALURA / Turkey	4	pcs

Equipment	Explanation	Brand / Orjin	Quantity	
	<b>Pressure Regulator</b> Air Inlet: 1/2 inch Filter : 20U Working Pressure : 05-9.9 Atu Working temperature : 5-60 ° C Water Capacity : 80 MI Air Permeability : 2200Lt / Dk	OSAKA / Japan	1	pcs
	<b>Compressed air line installation.</b> Polyurethane Pneumatic fittings	ALURA / Turkey	1	set
	<b>Compressed air line installation.</b> Polyurethane Pneumatic hose 10 mm.	ALURA / Turkey	1	set
	<b>Hand Tools Set</b> Mechanical Tool Kit 43 Pieces	CETA / Turkey	1	pcs
	<b>Hand Tools Set</b> 10 Piece Tube Flaring Tool Set	SUPER EGO / Spain	1	pcs
	<b>Hand Tools Set</b> Bearing extractor kit 30 - 75 mm	NT / Turkey	1	pcs

Equipment	Explanation	Brand / Orjin	Quantity	
	<b>304 Piece Tool Set</b>			
	Combination Wrench Set 1			
	Combination Wrench Set 1			
	Double Open End Wrench Set 1			
	Double Ring End Wrench Set 1			
	1/4" Drive Socket and Hex Key Set 1			
	1/2" Drive Socket Set (C21-12 Ratchet) 1			
	Drive Deep Socket Set 1			
	Drive TORX/Hex/XZN Socket Bits Set 1			
	C-PLUS Slotted/PH Screwdriver and Bit Set 1			
	C-PLUS TORX Screwdriver Set 1		1	pcs
	T-Handle and Ballpoint L Hex Key Set 1			
	DuoTech Pliers Set (Polished Finish) 1			
	Pliers and Adjustable Wrench Set 1			
	Circlip Pliers Set 1			
	Precision Pliers and Screwdriver Set 1			
	Measuring and Cutting Tool Set 1			
	Standard and Needle File Set 1			
	Hammer and Chisel Set 1			
	Drill Bit and Impact Screwdriver Set 1			
	Hand Riveter Set			