

No	Equipment	Explanation	Orjin	Piece
----	-----------	-------------	-------	-------

1		Bodywork	Alura Turkey	1
---	--	-----------------	-----------------	---



MWS Insulated Body - 6,00 Mt.
Production from twisted C type channel steel.
Base traverses 80mm height 3mm





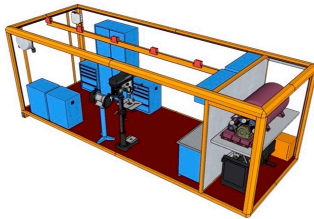

18 mm Elastomeric rubber insulation walls.
Floor 18mm Plywood plywood.
Sliding windows to usable areas.
Generator and compressor areas are quickly accessible cover.

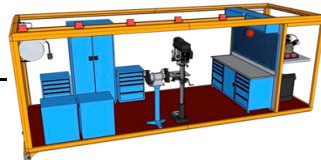





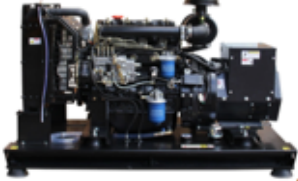



Exhaust and ventilation device.
Stainless hinges and locks.
Outside transportation center control board.







Electrical cables are hidden inside the insulated chassis.
Quick access cover to the lubricating and washing rollers.
Monolithic crane connection channel to the body frame.
Fixed glass rear door.
Environmental and interior lighting 220v.
Acrylic industrial chassis and surface paint.
Quick-access rear bumper drawers.
Metal items are fixed to the chassis.







No	Equipment	Explanation	Orjin	Piece
2		Electric Chain Hoist Capacity : 2 tons Lifting Height: 6 mt. Lifting Speed: 3.4 m/min Voltage: 380V/50HZ Class : M4 Net/Gross Weight: 76/82 kg Chain Class : G80	Pafter Kore	1
3		Piston Compressor Air Tank: 500 lt Engine Power: 5.5 hp Air Suction: 630 lt/min Pressure : 12 bar Revolution : 950 rpm	Aykom Turkey	1
4		Generator Diesel Standby Power: 19 / 21 kVA Working Power: 15 / 17 kW Output Voltage: 230 / 400 V Engine Speed: 1500 r.p.m Power Factor Cos Phi 0.8 0.8 Engine: PERKINS Engine Model: 404A22G1 Speed : 1500rpm. Cylinder : 4 Rows Cooling : Water Cooled	Power Turkey	1
5		Column Drill Drilling Capacity: 32 mm Mors Hive: 4 Hives Column Diameter : 130 mm Chuck : 1.0 - 16 mm M16 + Conical Engine Power: 1 Hp Engine Speed: 1.400 rpm Distance Between Spindle and Table : 780 mm Distance Between Spindle Column : 300 mm Distance Between Spindle Base : 1,280 mm Spindle Movement : 135 mm Length : 1920 mm Weight : 430 kg	Sevindik Turkey	1





No	Equipment	Explanation	Orjin	Piece
7.1		Air Blow Gun Set 16cm Additional Spray Tip Long 9 cm Additional Spray Tip Short Hose Connecting Nut Hose Connection End	Bay-Tec Turkey	1
7.2		Tire Inflator Gun with Indicator Analogue wide screen, solid aluminum body structure Possibility to use as bar, PSI or kPa Display illumination, protection class IP54 Reading accuracy 0.1 psi / 0.01 bar / 1 kPa Operating range 4 – 250 psi / 0.3 – 17.2 bar / 30 – 1723 kPa	Accura Italy	1
7.3		Washing Gun Metal body water gun with trigger locking mechanism With water control valve and 2 different types of spraying. Trigger direction can be brought forward or backward.	Karcher Germany	1
7.4		Air Screwdriver 6 MM Screw Length : 190mm Socket Capacity : 1/4" Screw Diameter : 6 mm Max. Torque: 4-8 Nm Idle Speed : 1,800 Rpm Working Pressure: 90-115psi (6.2-8.0 atu) Hose Diameter : 10 mm Air Inlet Nipple : 1/4" Air Consumption: 170 lt/min Weight : 1.10 kg	Osaka Japan	1
7.5		Electric Drill Rated input power: 1,300 W Weight: 2.85 kg No-load speed, 1st gear: 0 – 900 rpm No-load speed, 2nd gear: 3,000 rpm Power output: 695 W Rated speed: 3,000 rpm Rated torque: 7=8 / 2=6 Nm"	Bosch Germany	1



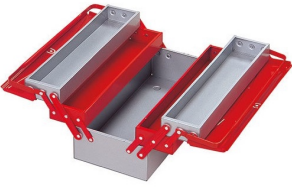

No	Equipment	Explanation	Orjin	Piece
7.6		35 Piece Concrete Drill Bit Set Cyl-3 concrete drill bits 2.5, 3.0, 4.0, 5.0, 8.0 Quick change adapter magnetic bit holder PH1, PH2, PH3 PZ1, PZ2, PZ3 SL3, SL4, SL5, SL6 HEX3, HEX4, HEX5, HEX6 TH10, TH15, TH20(x2), TH25, TH27, TH30, TH40 Socket 8 - 10 - 13 mm Hss Pointeq Metal Drill Bit Set: 13 Pieces Size : 1.5 - 2.0 - 2.5 - 3.0 - 3.2 - 3.5 - 4.0 - 4.5 - 4.8 - 5.0 - 5.5 - 6.0 - 6.5mm	Bosch Germany	1
7.7		Step Drill Bit Dimensions: 4 / 12 - 4 / 20 - 4 / 32 mm Material : Air Steel Coating : Titanium	Texa Kore	1
7.8		Table Top Grinding Machine Grinding disc diameter : 200 mm No-load speed: 3,600 rpm Grinding disc widths: 25 mm Grinding disc hub diameter : 32 mm Sand thickness: 24, 60 mm Input power: 600 W Weight : 15 kg Dimensions LxWxH: 230x370x260 mm	Bosch Germany	1
7.9		Angle Grinder Rated input power: 2,200 W Idle speed: 6,500 rpm Grinding spindle tooth: M 14 Main handle: Straight Disc diameter: 230 mm Rubber sanding pad diameter: 180 mm Dish disc diameter: 140 mm Tool dimensions: 110x475x140 mm Weight: 5.4 kg	Bosch Germany	1





No	Equipment	Explanation	Orjin	Piece
7.10		Grinding Wheels Diameter : 230 mm Core diameter : 22.23 mm Thickness : 7.0 mm	Bosch Germany	1
7.11		Grinding Wheels Diameter : 230 mm Core diameter : 22.23 mm Thickness : 3.0 mm	Bosch Germany	1
7.12		Oxygen Acetylene Welding and Cutting Set Pressure Reducing Oxygen: 1 pc. Pressure Reducing Acetylene: 1 pc. Handle: 1 pc. Cutting Torch: 1 pc. Cutting Bowl Set: 1 tsp. Welding Handle No: 4 pcs. Safety Valve Combustible Gas: 1 pc. Safety Valve Oxygen: 1 pc. Lighter : 1 pc. Bag : 1 pc	Yıldız Turkey	1
7.13		Oxygen / Acetylene Fireproof Welding Hose Size : 8 mm Length : 25 m Material : Thermoplastic	Sel Turkey	1
7.14		Combination Pliers Heavy Type Special alloy steel, cutting edges induction hardened Length : 180 mm / 200 mm	İzeltaş Turkey	1







No	Equipment	Explanation	Orjin	Piece
7.15		1/2" Twelve Corner Socket Wrench Socket Dimensions: 10 – 11 – 12 – 13 – 14 – 15 – 16 – 17 – 18 – 19 – 21 – 22 – 23 – 24 – 26 – 27 – 28 – 30 – 32 4150 24 1/2" Ratchet Handle Length : 250 mm 1/2" Joint Length : 70 mm 1/2" T Handle Adapter 1/2" Intermediate Arm Length : 125 – 250 mm	İzeltaş Turkey	1
7.16		Two Blades Key 8 pcs Set Long Size Body : Chrome Vanadium Coating : Chrome Size : 6x7 – 8x9 – 10x11 – 12x13 – 14x15 – 16x17 – 18x19 – 20x22 mm	İzeltaş Turkey	1
7.17		1/2" Twelve Corner Sockets Material : Vanadium Coating : Chrome Size: 10 - 11 - 12 - 13 - 14 - 15 - 16 - 17 - 18 - 19 - 20 - 21 - 22 - 23 - 24 - 26 - 27 - 28 - 30 - 32 mm	İzeltaş Turkey	1
7.18		1/4" Hexagon Socket Body: Chrome Vanadium Coating: Chrome 1/4" Hexagon Socket Wrench 4 – 5 – 6 – 7 – 8 – 9 – 10 – 11 – 12 – 13 1/4" Ratchet handle : 140 mm 1/4" Joint : 38 mm 1/4" T Arm : 115 mm 1/4" Intermediate Arm : 50 mm 1/4" Intermediate Arm : 100 mm	İzeltaş Turkey	1
7.19		Articulated Combination Spark Plug Socket Two sizes: 16 / 21 mm Arm length: 210 mm For spark plugs in the engine block, Hardened, heat treated, chrome plated forged steel nut, With rotary switch, spring,	İzeltaş Turkey	1







No	Equipment	Explanation	Orjin	Piece
7.20		Articulated T Arm Socket Material : Special alloy steel Coating : Chrome plated Socket Dimensions: 8 - 10 - 12 - 13 - 17 - 19 mm	İzeltaş Turkey	1
7.21		Rubber Hammer Length : 450 mm Head size : 60 mm	İzeltaş Turkey	1
7.22		Hammer 2 set Weight : 500 - 1.500 gr Length : 350 - 450 mm Head size : 30 - 40 mm Handle : Wood	İzeltaş Turkey	1
7.23		Lubricator Material: Metal Volume: 500cc Flexible Tip	İzeltaş Turkey	1
7.24		Spiral Magnet Screwdriver Capacity : 1000 gr. Length : 465mm. Weight : 105 gr.	İzeltaş Turkey	1
7.25		Feeler Knife Scale : 20 Sheets Length : 100mm	İzeltaş Turkey	1
7.26		Tool Bag Metal Lockable 5 Eyes 200X520X200	İzeltaş Turkey	1



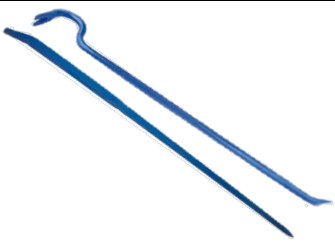



No	Equipment	Explanation	Orjin	Piece
7.27		Twelve Corner Socket Wrench Set 1/2" Twelve Corner Socket Wrench: 10 – 11 – 12 – 13 – 14 – 15 – 16 – 17 – 18 – 19 – 21 – 22 – 23 – 24 – 26 – 27 – 28 – 30 – 32 1/2" Ratchet Handle: 250 mm 1/2" Joint : 70 mm 1/2" T Handle Adapter 1/2" Intermediate Arm : 125 – 250 mm	izeltas Turkey	1
7.28		Dynamic 520 Start 230 V 12 - 24 V Mains Voltage: 230 V Rated Reference Capacity: 20 / 1000 Charge/Starter Voltage: 12 / 24 V Charge Current: 75 A Charge Rated Current: 300 A Starting Current: 400 A Machine Size: 365 x 460 x 755 mm Weight : 20 kg.	Telwin Italy	1
7.29		Air Grease Pump Volume : 10 kg Operation Type: Air Working Pressure: 6-8 Bar Compression Ratio: 45:1 Yield: 1.400 Gr/Min Capacity: 10 Kg Hose Length: 2 Mt Hose Size: R2 1/4"	Gulersan Turkey	1
7.30		Air Oil Pump Operation Type : Air Working Pressure: 6-8 Bar Pressure Ratio: 3:1 Yield: 15 Lt/Min Capacity : 30 Lt Hose Length: 2 Mt Hose Size: R1-3/8" Packing Size: 39x42x92 Cm Weight : 15.30 Kg	Gulersan Turkey	1







No	Equipment	Explanation	Orjin	Piece
7.31		Pipe Wrench (85°) set / 3 pcs. Material : Chrome Vanadium Teeth: Induction hardened Coating : Electrostatic Paint Size / Length: 1" / 325 mm Size / Length : 1/2" / 430 mm Size / Length: 2" / 585 mm	İzeltas Turkey	1
7.32		Wire brush Material : Steel wire Pattern : straight / hard / tight Handle : Wood Length : 150 mm.	KWB Turkey	1
7.33		Industrial 180 Watt soldering iron. Plastic Handle with key	Class Kore	1
7.34		Electric hand-held die Motor type: 230 Volt Unv. Motor power: 1350 W Die type: Right BSPT Die spacing: 1/2"-2" Capacity steel: 1/2" - 3/4" - 1" - 1 1/4" - 1 1/2" - 2" Weight: 22,800 kg	KNC Kore	1
7.35		Anvil 50kg	Kanca Turkey	1









No	Equipment	Explanation	Orjin	Piece
7.36		1/4" Hexagon Socket Body: Chrome Vanadium Coating: Chrome 1/4" Hexagon Socket Wrench 4 – 5 – 6 – 7 – 8 – 9 – 10 – 11 – 12 – 13 1/4" Ratchet handle : 140 mm 1/4" Joint : 38 mm 1/4" T Arm : 115 mm 1/4" Intermediate Arm : 50 mm 1/4" Intermediate Arm : 100 mm	İzeltas Turkey	1
7.37		1/2" Socket Adapter 1/2" F x 3/4" M Material : Chrome vanadium Coating : Chrome	İzeltas Turkey	1
7.38		Adjustable Ratchet Wrench 2 pcs Chrome Vanadium, Chrome Plated, PVC Insulated Length / Mouth Size: 8" 23 mm / 10" 28 mm	İzeltaş Turkey	1
7.39		Grease Pump Volume : 500 cc Weight : 1,320 kg	İzeltaş Turkey	1
7.40		Digital caliper Measuring Range: 0-150 mm / 0-6 Sensitivity : 0.01 mm / 0.0005 Display : LCD Lower Jaw Length: 40 mm Upper Jaw Length: 21 mm Repeatability : 0.01 mm On/Off Key: Yes Reset : Yes Measuring inch and mm : Yes Power Source: 1 x CR2032 battery	Insize Germany	1







No	Equipment	Explanation	Orjin	Piece
7.41		Steel Tape Measure Length : 5 Mt Strip Width: 19 Mm Shockproof ABS Case Ergonomic Grip for Extra Comfort Belt Clip and Carry Strap	Insize Germany	1
7.42		Standard Puller Two Arms Chrome vanadium, Zinc plated, Handles hardened, shaft induction hardened. Depth: 200 mm. Width : 350mm. Weight : 10 kg.	İzeltaş Turkey	1
7.43		Screw Extractor Spiral Flute 6-Piece Set includes spiral flute screw extractors sizes EX-1, EX-2, EX-3, EX-4, EX-5, and EX-6	Ultechnovo Kore	1
7.44		Crowbar Corrugated Curved Tip Size : 600mm	İzeltaş Turkey	1
7.45		Wheel Wrench Dimensions: 24 - 27 - 32 mm - 3/4 "	İzeltaş Turkey	1
7.46		Hydraulic Bottle Jack Capacity: 15 tons min. height: 230mm Lifting height: 150 mm Adjustable height: 80 mm Net weight: 8.9 kg	Atlas Kore	1







No	Equipment	Explanation	Orjin	Piece
7.47		Crowbars 2 pcs Length : 100 / 150 cm Average Weight : 10kg hot forging, Coating : Blue paint, Induction Hardened.	Atlas Kore	1
7.48		Steel Gas Can Volume : 20 Liters Size : 36x16x47cm Weight : 3.6 kg. Material : Steel Wall Thickness: 0.8 mm	Steweld Kore	1
7.49		Funnel Capacity : 1.2 Lt. Type : Spiral Material : Funnel HDPE Lower / Upper Mouth : 40 mm / 160 mm Bottom Mouth Diameter: 13 mm Spiral / Length : 440 mm / 330 mm	İzeltas Turkey	1
7.50		First-aid kit Material : ABS Plastic Wall mount Product size: 32.2cm x 24.2cm x 12.2cm	FirstPlus Turkey	1
7.51		Fire extinguisher Metartel : Carbon dioxide gas Capacity : 6 Kg.	Guvem Turkey	1
7.52		Inner Circlip Pliers Courbe 2 pcs. Material : Chrome Vanadium Coating : Chrome, PVC Insulated Segment Size: 19 – 60 / 40 – 100mm Length : 170 mm	İzeltas Turkey	1







No	Equipment	Explanation	Orjin	Piece
7.53		Inner Circlip Pliers 2 pcs. Material : Chrome Vanadium Coating : Chrome, PVC Insulated Segment Size: 19 – 60 / 40 – 100mm Length : 170 mm	izeltas Turkey	1
7.54		Outer Circlip Pliers Courbe 2 pcs. Material: Chrome Vanadium Coating : Chrome, PVC Insulated Segment Size: 19 – 60 / 40 – 100mm Length : 170mm"	izeltas Turkey	1
7.55		Outer Circlip Pliers 2 pcs. Material: Chrome Vanadium Coating : Chrome, PVC Insulated Segment Size: 19 – 60 / 40 – 100mm Length : 170mm"	izeltas Turkey	1
7.56		Lock Ring Pliers Material: Hardened Metal Item Dimensions LxWxH : 10.5 x 0.9 x 5.9 inches Product Weight: 4.8 Ounces	izeltas Turkey	1
7.57		Hose Clamp Pliers Model : Compression Length : 235mm	izeltas Turkey	1
7.58		Combination Pliers Length : 200 mm Weight: 315 gr. Special alloy steel Cutting edges induction hardened	izeltas Turkey	1
7.59		Side Cutter Pliers Length : 180 mm Weight : 230 g Special alloy steel, Cutting edges induction hardened	izeltas Turkey	1



No	Equipment	Explanation	Orjin	Piece
7.60		Metal Saw Handle Length : 300mm. Weight 550 gr.	izeltas Turkey	1
7.61		Hacksaw Spare Dimension : 300 mm Package Content: 10 Pieces Material : Carbon Steel	izeltas Turkey	1
7.62		Pliers Length : 250mm Weight : 530 gr. Material : Special alloy steel Cutting edges: Induction hardened, Handle : PVC insulated	izeltas Turkey	1
7.63		Pliers Set Combination Pliers Opaque Series 1 pc. Length : 160 mm. Nose Pliers Flat End Opaque Series 1 ad . Length : 160 mm. Side Cutters Opaque Series 1 pc. Length 160mm.	izeltas Turkey	1
7.64		Universal Fort Pliers Length : 240mm Weight : 355 gr. Material : Vanadium Coating : Chrome Handle : PVC insulated	izeltas Turkey	1
7.65		Standart Adjustable Pliers Length : 250mm. Weight : 560 gr. Material: Vanadium Steel. Coating : Nickel Plated Usage Area: Round and Flat Materials.	izeltas Turkey	1



No	Equipment	Explanation	Orjin	Piece
7.66		Universal Adjustable Pliers Length : 250mm. Weight : 560 gr. Material: Vanadium Steel. Coating : Nickel Plated Usage Area: Round and Flat Materials.	izeltas Turkey	1
7.67	  	Single Blade Cable Cutter Length / Weight : 165 mm / 210 mm Material : Special alloy steel Mouth : Induction hardened Handle : PVC insulated Insulated Single Blade Cable Cutter Length / Weight : 165 mm / 150 mm Material : Special alloy steel Mouth : Induction hardened Handle : PVC insulated Double Edge Cable Cutter Length / Weight : 220 mm / 320 mm Material : Special alloy steel Mouth : Induction hardened Handle : PVC insulated	izeltas Turkey	1
7.68		Steel Pipe Cutter Size range: 1/8" – 2" Weight: 2.380 gr.	izeltas Turkey	1
7.69		Non-Insulated Terminal Crimping Pliers Size range : 1.00 - 10 mm. Length : 255mm. Weight : 360	izeltas Turkey	1
7.70		Terminal Crimping Pliers Size range: 1-4 mm Length : 350mm Weight : 230 gr.	izeltas Turkey	1
7.71		Terminal Ferrule Crimping Pliers Material: High carbon steel Clamping Type: 4 corner clamping Heavy duty ratchet crimping pliers Wider compression range up to 0.25-10mm ² Crimp Connectors : 1,250 pcs	izeltas Turkey	1



No	Equipment	Explanation	Orjin	Piece
7.72		Metal Utility Knife Knife: 10 Pieces Metal body, metal tip and impact resistant, long-lasting utility knife.	BKS Türkey	1
7.72.1		Metal Utility Knife Tip Package : 10 pcs. 10 packs.	BKS Türkey	1
7.73		Combination Key 12 pcs Set Long Size Body : Chrome Vanadium Coating : Chrome Size : 8 – 9 – 10 – 11 – 12 – 13 – 14 – 15 – 16 – 17 – 19 – 22 mm	İzeltas Turkey	1
7.74		Flat Chisel 27x200 mm Weight: 340 gr. 30x300 mm Weight: 635 gr.	İzeltas Turkey	1
7.75		Chisel set 6 pcs Leveler flat chisel Length : 125 mm Leveler flat chisel Length : 150 mm Nail chisel Length : 130 mm Point punch Size : 4x120 mm Straight pin punch Dimension : 5x150 mm Conical pin punch : 3x120 mm	İzeltas Turkey	1
7.76		Straight Pin Punch Set 6 pieces Dimensions: 3 – 4 – 5 – 6 – 7 – 8 mm Weight : 865 gr.	İzeltas Turkey	1
7.77		Dotting Pen Size: 1/8" - 3mm Length: 4. 1/4" - 108mm Carbon steel one-piece hex shank	İzeltas Turkey	1



No	Equipment	Explanation	Orjin	Piece
7.78		Round Head Allen Key Set 9 pieces 1.5 – 2 – 2.5 – 3 – 4 – 5 – 6 – 8 – 10 mm	izeltas Turkey	1
7.79		Round Head Allen Key Set inch 9 pieces 3/32, 7/64, 1/8, 9/64, 5/32, 3/16, 7/32, 1/4, 5/16 inch	izeltas Turkey	1
7.80		Two Blades Key 8 pcs Set Long Size Body : Vanadium Coating : Chrome Size : 6×7 – 8×9 – 10×11 – 12×13 – 14×15 – 16×17 – 18×19 – 20×22 mm	izeltas Turkey	1
7.81		T Type Round Head Allen Key Set Dimensions: 1.5 – 2 – 2.5 – 3 – 4 – 5 – 6 – 8 – 10 mm Weight : 355 gr.	izeltas Turkey	1
7.82		Allen Key Hexagonal Material : Chrome Vanadium Coating : Nickel Size: 14 mm Length: 140 mm. Size: 16 mm Length: 152 mm. Size: 17 mm Length: 160 mm. Size: 19 mm Length: 180 mm.	izeltas Turkey	1
7.83		Allen Key Hexagonal Material : Chrome Vanadium Coating : Nickel Size: 14 mm Length: 140 mm. Size: 16 mm Length: 152 mm. Size: 17 mm Length: 160 mm. Size: 19 mm Length: 180 mm.	izeltas Turkey	1
7.84		Chisel Set 6 Pieces Dimensions: 10 – 12 – 14 – 16 – 18 – 20 mm Weight : 985 gr.	izeltas Turkey	1





No	Equipment	Explanation	Orjin	Piece
7.85		Carbide-tipped engraving pen The permanent, penciled mechanical handle prevents concrete from breaking. This pen has a finely sanded needle tip and a 15 cm long handle body.	İzeltas Turkey	1
7.86		Metal Miter Size : 200 x 300 cm Material : Inox	İzeltas Turkey	1
7.87		Tire Lever 610 Mm	İzeltas Turkey	1
7.88		Double Chain Oil Filter Remover Size range: 60 - 160 mm. Weight : 380 gr.	İzeltaş Turkey	1
7.89		Stilson Pipe Wrench Material: Chrome vanadium Processing : Teeth induction hardened, Coating : Electrostatic painted Length : 300mm / 12" Mouth Diameter: 42 mm. Weight : 725 gr.	İzeltas Turkey	1
7.90		Drill Bit 5 pcs Dimensions: 24 / 25 / 27 / 30 / 35 mm. It is resistant to high temperatures up to 600°C.	MKE Turkey	1
7.91		Torture 3 pcs Length : 200 / 500 / 700 mm. Weight : 2.550 / 3.300 / 3.900 gr. Jaw depth: 120 / 120 / 120 mm. Material : Forged Steel Handle : Wood	Kanca Turkey	1





No	Equipment	Explanation	Orjin	Piece
7.92		Digital Multimeter 1000V AC / DC ; 20A AC / DC True RMS, 6000 counts Dual range NCV test that quickly identifies neutral and live wires with light intensity Audible / visual alarm Capacitor charge indicator ergonomic design double injection molding 1m drop resistant Flashlight; auto backlight	Unit Italy	1
7.93		Single Blade Crown Wrench Material: Chrome vanadium. Size/Length/Weight:36mm/300mm/370gr. Size/Length/Weight:41mm/345mm/550gr. Size/Length/Weight:46mm/390mm/750gr. Size/Length/Weight:50mm/423mm/1.000gr. Size/Length/Weight:55mm/455mm/1.300gr. Size/Length/Weight:60mm/490mm/1.600gr. Size/Length/Weight:65mm/524mm/1.980gr.	izeltas Turkey	1
7.94		Combination Screwdriver Set 8 pcs. Body : Chrome Vanadium Coating : Chrome plated Tip : Tip black oxide Handle : Cellulose acetate handle Flat : 3x80 – 4x80 – 4x100 – 5x125 – 6x150 - Star : 4.5x80 – 6x100 – 8x150	izeltas Turkey	1
7.95 CASE HOLDER BASE				
7.95				
7.96 CASE BAR				
7.96				



No	Equipment	Explanation	Orjin	Piece
7.97		<p>Metal Drawer Set 6 Drawer Width / Depth / Height: 815 / 450 / 900 mm Drawer Quantity and Size: 6 Drawer Carrying Capacity: 45 kg. Drawer Rail System: Latch / Telescopic Top Table : 4 Section ABS Locking System: Central Lock Body Color : RAL 5015 / Rough Wheels: 2 with swivel, 1 with brake Drawer Color RAL 5015</p> <p>Width / Depth / Height: 615 / 450 / 900 mm Drawer Quantity and Size: 5 Drawer Carrying Capacity: 35 kg. Drawer Rail System: Latch / Telescopic Top Table : 4 Section ABS Locking System: Central Lock Body Color : RAL 5015 / Rough Drawer Color RAL 5015</p>	Alura Turkey	1
7.98		<p>Metal Drawer Set 3 Drawer Width / Depth / Height: 615 / 450 / 550 mm Drawer Quantity and Size: 3 Drawer Carrying Capacity: 30 kg. Drawer Rail System: Latch / Telescopic Top Table : 4 Section ABS Locking System: Central Lock Body Color : RAL 5015 / Rough Wheels: 2 with swivel, 1 with brake Drawer Color RAL 5015</p> <p>Width / Depth / Height: 615 / 450 / 900 mm Drawer Quantity and Size: 5 Drawer Carrying Capacity: 35 kg. Drawer Rail System: Latch / Telescopic Top Table : 4 Section ABS Locking System: Central Lock Body Color : RAL 5015 / Rough Drawer Color RAL 5015</p>	Alura Turkey	1

No	Equipment	Explanation	Orjin	Piece
7.99		Metal Drawer Set 5 Drawer Width / Depth / Height: 615 / 450 / 750 mm Drawer Quantity and Size: 5 Drawer Carrying Capacity: 40 kg. Drawer Rail System: Latch / Telescopic Top Table : 4 Section ABS Locking System: Central Lock Body Color : RAL 5015 / Rough Wheels: 2 with swivel, 1 with brake Drawer Color RAL 5015 Width / Depth / Height: 615 / 450 / 900 mm Drawer Quantity and Size: 5 Drawer Carrying Capacity: 35 kg. Drawer Rail System: Latch / Telescopic Top Table : 4 Section ABS Locking System: Central Lock Body Color : RAL 5015 / Rough Drawer Color RAL 5015	Alura Turkey	1
7.100		Metal Drawer Set 4 Drawer Width / Depth / Height: 615 / 450 / 650 mm Drawer Quantity and Size: 5 Drawer Carrying Capacity: 35 kg. Drawer Rail System: Latch / Telescopic Top Table : 4 Section ABS Locking System: Central Lock Body Color : RAL 5015 / Rough Wheels: 2 with swivel, 1 with brake Drawer Color RAL 5015 Width / Depth / Height: 615 / 450 / 900 mm Drawer Quantity and Size: 5 Drawer Carrying Capacity: 35 kg. Drawer Rail System: Latch / Telescopic Top Table : 4 Section ABS Locking System: Central Lock Body Color : RAL 5015 / Rough Drawer Color RAL 5015	Alura Turkey	

No	Equipment	Explanation	Orjin	Piece
7.101		<p>Manual Paper Towel Machine It saves 1/3 of paper. Hospital etc. It is suitable for use in hygienic environments. It is perfectly compatible for roll paper towels between 19 cm and 21 cm. Color : White It has a locked mechanism.</p>	Viva Turkey	1
7.102		<p>Metal Cabinet Width: 1.000 mm Depth: 450 mm Height: 2000 mm Number of Shelves: 7 Pieces Shelf Carrying Cap .: 80 kg. Variable drawer groups Body and carriers 0.80 - 1.2 mm sheet metal It is long-lasting and durable. The covers are double wing reinforced."</p>	Alura Turkey	1
7.103		<p>Work Bench Width: 1.500 mm Depth: 750 mm Height: 825 mm Number of Drawers: 5 piece Drawer Carrying Capacity: 60 kg. Shelf Carrying Cap .: 80 kg. Socket 2 Pieces 25 mm MDF + Pvc on worktops Telescopic rails with 100% opening in drawers Central locking system in drawers Electrostatic powder paint Suspension boards modular Standard 2 220V sockets in electrically connected workbenches</p>	Alura Turkey	1

No	Equipment	Explanation	Orjin	Piece
7.104		Bench Vice Size : 100 mm Jaw Width : 100 mm Total Lenght : 300 mm Arvil Size : 40x60 mm Vice Heaighy : 110 mm	İzeltas Turkey	1
7.105		Hand Grinding Input power : 1,700 W Idle speed: 2,800 – 11,500 rpm Output power: 1,010 W Grinding spindle tooth : M 14 Disc diameter : 125 mm Rubber sanding pad diameter : 125 mm Cup brush diameter: 75 mm Length : 311mm Height : 103mm Weight : 2.4 kg	Bosch Germany	1
7.106		Air Grinder Length : 155mm Collet Diameter: 6 mm Cup Diameter : 38.00 mm Idle Speed : 25,000 rpm Hose Diameter: 9.5 mm Air Inlet Nipple : 1/4" Air Consumption: 178 lt/min Working Pressure: 90 psi 6.2 atu Weight : 0.50 kg	Osaka Japan	1
7.107		Long Crowbar Dismantling Iron 80 Cm Material : Casting Coating : Blue Paint	Demirci Turkey	1

No	Equipment	Explanation	Orjin	Piece
7.108		Welder Superior 320 Ce Vrd Mains Voltage: 400 V Drawn Power: 12 / 20 kW Power Factor: 0.9 cos Yield: 0.9 n Idle Operating Voltage: 52.8 V Current Setting Range: 10 - 270 A Rated Current: 270A - 35% Electrode Diameter: 1.6 - 6.0 mm Protection Class: IP23 Machine Size: 460 x 190 x 360 mm Weight: 10.2 kg	Telwin Italy	1
7.109		Drill Vise Size : 125 mm Material : Casting Coating: Electrostatic paint	Kanca Turkey	1
7.110		Rechargeable Led Flashlight Light power: 5W AC input voltage : AC90-240V 50 / 60HZ Charge Current: 0.22A 1.4W	Swat Kore	1
7.111		Fire Extinguisher Cabinet Material : Plastic Capacity : 6 Kg. Cover : Locked Color : Red	Arlı Turkey	1

No	Equipment	Explanation	Orjin	Piece
7.112		Aluminum Ladder Number of Digits: 4+1 Additional table step Special alloy aluminum ladder Easy opening and closing Single stylish packaging ready to use Anti-scratch plastic wedges Specially designed anti-slip steps Decorative use in homes and businesses Very light and strong in carrying loads Long lasting stainless maximum strength	Saray Turkey	1
7.113		Mobile Metal Reel 2 pcs 1 Piece (3X25 A) 2 Pieces (1X16 A) Covered Socket (5X2,5) 40 Meter Capacity Bronze ContactsHeat Resistant Contact Housing Terminal Connection System With IP 44 Protection 100 m Cable	Bemis Turkey	1